



Most Widely Accepted and Trusted

ICC-ES Evaluation Report

ESR-1389

ICC-ES | (800) 423-6587 | (562) 699-0543 | www.icc-es.org

Reissued 01/2018
This report is subject to renewal 01/2019.

DIVISION: 07 00 00—THERMAL AND MOISTURE PROTECTION
SECTION: 07 31 13—ASPHALT SHINGLES

REPORT HOLDER:

CERTAINTEED CORPORATION

EVALUATION SUBJECT:

CERTAINTEED ASPHALT SHINGLES



“2014 Recipient of Prestigious Western States Seismic Policy Council (WSSPC) Award in Excellence”



ICC-ES Evaluation Reports are not to be construed as representing aesthetics or any other attributes not specifically addressed, nor are they to be construed as an endorsement of the subject of the report or a recommendation for its use. There is no warranty by ICC Evaluation Service, LLC, express or implied, as to any finding or other matter in this report, or as to any product covered by the report.



ICC-ES Evaluation Report

ESR-1389

Reissued January 2018

Revised July 2018

This report is subject to renewal January 2019.

www.icc-es.org | (800) 423-6587 | (562) 699-0543

A Subsidiary of the International Code Council®

DIVISION: 07 00 00—THERMAL AND MOISTURE PROTECTION

Section: 07 31 13—Asphalt Shingles

REPORT HOLDER:

CERTAINTEED CORPORATION

EVALUATION SUBJECT:

CERTAINTEED ASPHALT SHINGLES

1.0 EVALUATION SCOPE

Compliance with the following codes:

- 2018, 2015, 2012 and 2009 *International Building Code*® (IBC)
- 2018, 2015, 2012 and 2009 *International Residential Code*® (IRC)
- 2013 *Abu Dhabi International Building Code* (ADIBC)[†]

[†]The ADIBC is based on the 2009 IBC. 2009 IBC code sections referenced in this report are the same sections in the ADIBC.

Properties evaluated:

- Weather resistance
- Fire classification
- Wind resistance

2.0 USES

The CertainTeed asphalt shingles described in this report comply with ASTM D3462 and are Class A roof coverings when installed as described in this report.

3.0 DESCRIPTION

3.1 General:

CertainTeed asphalt shingles are available as three-tab, four-tab, no cut-out and laminated asphalt shingle roof covering materials. See Table 1 and Figure 1 for recognized product names, shingle types, manufacturing locations, overall dimensions, installed weights, maximum exposure to the weather, and fastening details. The shingles are self-sealing by means of adhesive strips located on either the weather side or the underside. See Figure 1 for adhesive strip location for field shingles and Starter Strip shingles.

3.2 Three-tab, Four-tab and No Cut-out Shingles:

Three-tab, four-tab and no cut-out shingles are composed of a single layer of fiberglass mat, impregnated and coated

with asphalt on both sides, and surfaced with mineral roofing granules on the weather side and a mineral release agent on the back side.

3.3 Laminated Shingles:

Laminated shingles, including two-layer laminated, three-layer laminated and tri-laminate laminated shingles, are composed of multiple thicknesses of coated and surfaced fiberglass mat, cut and bonded together in different patterns. The weather side is surfaced with mineral roofing granules, and the back side is surfaced with a mineral release agent.

3.4 Accessory Shingles:

3.4.1 Hip and Ridge Shingles: Hip and ridge shingles are factory-made shingles to be used for covering hips and ridges. The hip and ridge shingles are composed of the same materials as the roof shingles. Some of the hip and ridge shingles have perforations that extend from the top of the cut-out to the top of the shingle, which facilitate the tearing of the shingle into three or four equal pieces. Others are manufactured as single hip and ridge units.

3.4.2 Starter Strip Shingles: Starter Strip shingles are factory-made shingles to be used as the starter course (under the first course of roof shingles). The Starter Strip shingles are composed of the same materials as the roof shingles. The shingles are supplied in 7-inch-by-36-inch-long (178 by 914 mm); 10-inch-by-36-inch-long (254 by 914 mm); or 7-inch-by-39³/₈-inch-long (178 by 1000 mm) strips. As an alternative to factory-made starter strips, starter strips can be formed by removing the lower tab portions of the factory-made shingles except for the Presidential Shake and Presidential Shake TL shingles. For Presidential Shake and Presidential Shake TL shingles, the Presidential Starter shingles consist of one 13¹/₄-inch-wide-by-40-inch-long (337 mm by 1016 mm) base shingle and one 11¹/₄-inch-wide-by-40-inch-long (286 mm by 1016 mm) base shingle.

3.5 Fasteners:

Fasteners must comply with ASTM F1667 and must be minimum No. 12 gage [0.105-inch-diameter (2.67 mm) shank], ³/₈-inch-diameter-head (9.5 mm), galvanized steel, stainless steel, aluminum or copper roofing nails. Fasteners must be of sufficient length to penetrate into the sheathing ³/₄ inch (19.1 mm), or through the sheathing, whichever is less.

3.6 Underlayment:

Under the 2018, 2015, 2012, and 2009 IBC, the roof underlayment must be in accordance with Section

1507.2.3. Under the 2018 and 2015 IRC, the roof underlayment must be in accordance with Section R905.1.1 and Table R905.1.1(1). Under the 2012 and 2009 IRC, the roof underlayment must be in accordance with Section R905.2.3. The roof underlayment must comply with ASTM D226 Type I or Type II, ASTM D4869 Type I or Type II, ASTM D6757 or ASTM D1970. As an alternative, a roof underlayment recognized in a current ICC-ES evaluation report as a roof underlayment or a nonasphaltic fiberglass-based roof underlayment may be used, provided it is recognized as being intended for use with Class A asphalt shingles. In areas where there has been a history of ice forming along the eaves causing a backup of water, ice dam protection in accordance with 2018 IBC Section 1507.2.8.1 (2015, 2012 and 2009 IBC Section 1507.2.8.2 or 2018 and 2015 IRC Section R905.2.7 [2012 and 2009 IRC Section R905.2.7.1]) must be provided.

3.7 Asphalt Cement:

Asphalt roofing cement must comply with ASTM D4586, Type I, Class I, or Type II, Class I.

4.0 INSTALLATION

4.1 New Construction:

4.1.1 General: When installed on new construction in accordance with this section, the shingles are a Class A roof covering. The shingles must be installed in accordance with IBC Section 1507.2 or IRC Section R905.2, except as noted in this report. The roof deck must be code-complying, minimum $\frac{3}{8}$ -inch-thick (9.5 mm) exterior-grade plywood; $\frac{7}{16}$ -inch-thick (11.1 mm) oriented strand board (OSB); or nominally 1-inch-by-6-inch lumber installed as solid sheathing conforming to 2018 and 2015 IBC Section 2304.8.2 and 2308.7.10 [2012 and 2009 IBC Sections 2304.7.2 or 2308.10.8]. Minimum roof slope must be 2:12 (16.7%). The maximum roof slope must be as stated in Section 4.1.2 of this report. Installation instructions are included as part of the identification label attached to each bundle of shingles. (See Section 7.0.) Underlayment must be as described in Section 3.6 of this report, and applied in accordance with 2018 IBC Table 1507.1.1(2) [2015, 2012 and 2009 IBC Section 1507.2.8] or 2018 and 2015 IRC Section R905.1.1, Tables R905.1.1(2) and R905.1.1(3) and Section R905.2.3, or 2012 and 2009 IRC Section R905.2.7, as applicable.

4.1.2 Application:

4.1.2.1 Eave Edges of the Roof:

4.1.2.1.1 Roof Slopes of 2:12 to 21:12 (16.7% to 175%): Starter Strip shingles must be attached to the eave edges with four or five fasteners, equally spaced along the nail line as shown in Figure 1. The Starter Strip shingles must overhang the eave and rake edges by $\frac{1}{2}$ to $\frac{3}{4}$ inch (12.7 to 19.1 mm).

4.1.2.1.2 Roof Slopes Greater than 21:12 (175%): Starter Strip shingles must be attached to the eave edges with four or five fasteners, equally spaced along the nail line as shown in Figure 1. The Starter Strip shingles must overhang the eave and rake edges by $\frac{1}{2}$ to $\frac{3}{4}$ inch (12.7 to 19.1 mm).

4.1.2.2 Field of the Roof: The first course of field shingles must be installed over the starter course. Each course of shingles must be offset from the preceding course as specified in Table 1. Fastening details, including number and location of fasteners, and maximum exposure to the weather, are described in Table 1 and Figure 1.

Methods of fastening for roof slopes of 2:12 (16.7%) to 21:12 (175%) and for roof slopes greater than 21:12 (175%) are as shown in Figure 1 for the standard and high-wind applications. For slopes greater than 21:12 (175%), the shingles must also be hand-sealed as described in Section 4.1.2.4.

4.1.2.3 High Wind Fastening: Shingles must be fastened with four or five No. 12 gage roofing nails, described in Section 3.6, as shown in Figure 1, when the shingles are installed under the following conditions:

4.1.2.3.1 2018, 2015 and 2012 IBC: When the roof is installed in applications where the ultimate design wind speed, V_{ult} , is 140 mph (224 km/hr) or greater.

4.1.2.3.2 2009 IBC: When the roof is installed in applications where the basic wind speed is 110 mph (177 km/h) or greater.

4.1.2.3.3 2018 and 2015 IRC: When the roof is installed in applications where the ultimate design wind speed, V_{ult} , is 140 mph (224 km/hr) or greater.

4.1.2.3.4 2012 and 2009: When the roof is installed in areas where the basic wind speed is 110 mph (177 km/h) or greater.

4.1.2.4 Shingle Sealing: In colder climates or wind regions where it is questionable whether the factory-applied adhesive will activate and seal the shingles, the shingles must be hand-sealed to the satisfaction of the code official. Hand-sealing must consist of applying a minimum of four 1-inch-diameter (25.4 mm) spots of asphalt roofing cement to the unexposed surface of the underlying course of shingles, equally spaced across each shingle. For three-tab and four-tab shingles, one spot of asphalt roofing cement must be placed under each corner of each tab (two spots per tab); the tab must then be pressed into the cement. For laminated shingles, four equally spaced spots of asphalt roofing cement must be placed under the exposed portion of the shingle; the shingle must then be pressed into the cement.

4.1.2.5 Hip and Ridge Shingles: Hip and ridge shingles must be placed evenly over hips and ridges (or over shingle-over ridge vents), and fastened to the roof deck with two fasteners, located on either side of the shingle, along the nail line.

4.1.3 Valley Construction and other Flashing: For open valleys, corrosion-resistant metal valley flashing must be centered and placed vertically in the valley over the smooth-surfaced roll roofing, or specialty underlayment.

Corrosion-resistant metal valley flashing must be as follows:

- 2018, 2015, 2012 and 2009 IBC: A minimum of 24 inches (610 mm) wide, complying with 2018 IBC Table 1507.2.8.2 [2015, 2012 and 2009 IBC Table 1507.2.9.2].
- IRC: A minimum of 24 inches (610 mm) wide, complying with IRC Table R905.2.8.2.

Other flashing must be in accordance with IBC Section 1503.2 and 2018 IBC Section 1507.2.8 [2015, 2012 and 2009 IBC Section 1507.2.9] or IRC Sections R903.2 and R905.2.8, as applicable.

4.2 Installation—Reroofing:

When installed over existing or Class A or Class C asphalt shingle roofs in accordance with this section (Section 4.2), the shingle products are recognized as Class A roof coverings. The existing wood or asphalt shingle roof covering must be inspected in accordance with provisions

and limitations of 2018 and 2015 IBC 1511 [2012, 2009 and 2006 IBC Section 1510] or 2018 and 2015 IRC Section R908 [2012, 2009 and 2006 IRC Section R907], as applicable. Prior to the reroofing, hip and ridge covering must be removed. Except as noted in this section, the shingles must be installed in accordance with Section 4.1 of this report. Fasteners must be of sufficient length to penetrate $\frac{3}{4}$ inch (19.1 mm) into the sheathing, or through the sheathing, whichever is less. Valley flashing and other flashings must comply with Section 4.1.3 of this report and the following, as applicable:

- IBC: 2018 and 2015 IBC Sections 1511.5 and 1511.6 [2012 and 2009 IBC Section 1510.5 and 1510.6].
- IRC: 2018 and 2015 IRC Section R908.5 and R908.6 [2012 and 2009 IRC Section R907.5 and R907.6].

The following asphalt shingles may be installed over existing wood shingle roofs provided all of the conditions specified above are met:

Grand Manor, Carriage House, Presidential Shake TL, Presidential Shake, Presidential Shake IR, Presidential Solaris, Presidential TL Solaris Landmark TL, Landmark Premium, Landmark Solaris, Landmark Pro, Landmark Pro Solaris, Landmark Solaris Gold/Platinum, Landmark Pro Architect 80, Landmark, Landmark IR, XT-30, XT-30 IR, XT-25, CT-20, Independence, Hatteras, Highland Slate, Highland Slate IR, NorthGate, Patriot, Shangle Ridge, Cedar Crest IR, Mountain Ridge, Arcadia Shake, Belmont, Belmont IR and Shadow Ridge.

4.3 Wind Resistance:

CertainTeed asphalt field shingles have been tested in accordance with ASTM D7158 and are classified as Class H. CertainTeed asphalt hip and ridge shingles have been tested in accordance with ASTM D3161 and are classified as Class F. They qualify for use in locations as shown in 2018 and 2015 IBC Table 1504.1.1 [2012 and 2009 IBC Table 1507.2.7.1 (1)] and 2018 and 2015 IRC Table R905.2.4.1 [2012 and 2009 IRC Table R905.2.4.1 (1)]. Installation must be in accordance with 2018 IBC Section 1507.2.6 [2015, 2012 and 2009 IBC Section 1507.2.7] or IRC Section R905.2.6, as applicable.

5.0 CONDITIONS OF USE

The CertainTeed Asphalt Shingle Roof Covering Systems described in this report comply with, or are suitable

alternatives to what is specified in, those codes listed in Section 1.0 of this report, subject to the following conditions:

- 5.1 The shingles must be manufactured, identified, and installed in accordance with the applicable codes, this report, and the manufacturer's published installation instructions. If there is a conflict between the manufacturer's published installation instructions and this report, this report governs.
- 5.2 The products are manufactured in Avery, Ohio (AV); Ennis, Texas (EN); Fremont, California (FR); Norwood, Massachusetts (NW); Oxford, North Carolina (OX); Peachtree City, Georgia (PT); Portland, Oregon (PO); Shakopee, Minnesota (SH); Shreveport, Louisiana (SP); Jonesburg, Missouri (JB) and Wilmington, California (WI).

6.0 EVIDENCE SUBMITTED

- 6.1 Data in accordance with ASTM D3462.
- 6.2 Reports of wind resistance testing in accordance with ASTM D3161 and ASTM D7158.
- 6.3 Quality documentation.

7.0 IDENTIFICATION

- 7.1 Each bundle of shingles bears a label with the name and address of the CertainTeed Corporation manufacturing plant; the product brand name; the Class A roof classification; the installation instructions; and the evaluation report number (ESR-1389). Additionally, in accordance with ASTM D3462, each bundle of shingles is marked with the area of the roof surface covered and the style, type and color of the product.
- 7.2 The report holder's contact information is the following:

CERTAINTEED CORPORATION
20 MOORES ROAD
MALVERN, PENNSYLVANIA 19355
(610) 893-6096
www.certainteed.com

TABLE 1—PRODUCT DESCRIPTIONS AND MANUFACTURING LOCATIONS

PRODUCTS	SHINGLE TYPE	PLANT LOCATION	PLANT DESIGNATION	DIMENSIONS (width x height) (inches)	MAXIMUM EXPOSURE TO THE WEATHER (inches)	LOCATION OF NAIL "LINE" (distance above shingle butt) (inches)
SHINGLES (See Note 1)						(See Note 2)
Grand Manor	3-Layer Laminated	Oxford, NC	OX	36 x 18	8	8 ⁵ / ₈
Carriage House	2-Layer Laminated	Oxford, NC	OX	36 x 18	8	8 ⁵ / ₈
Presidential Shake TL	Tri-Laminate	Fremont, CA; Shakopee, MN	FR SH	40 x 14 ¹ / ₄	4	9
Presidential TL Solaris	Tri-Laminate	Fremont, CA	FR	40 x 14 ¹ / ₄	4	9
Presidential Shake	Laminated	Fremont, CA; Shakopee, MN	FR SH	40 x 14 ¹ / ₄	4	9
Presidential IR	Laminated Impact Resistant	Shakopee, MN	SH	40 x 14 ¹ / ₄	4	9
Presidential Solaris	Laminated	Fremont, CA	FR	40 x 14 ¹ / ₄	4	9
Landmark TL	Tri-Laminate	Fremont, CA; Oxford, NC	FR OX	40 x 13 ¹ / ₄	5 ⁵ / ₈	6 ¹ / ₁₆
Landmark Premium	Laminated (Metric)	Avery, OH; Norwood, MA; Oxford, NC; Peachtree City, GA; Portland, OR; Shakopee, MN; Shreveport, LA; Wilmington, CA	AV, NW, OX, PT, PO, SH, SP, WI	38 ³ / ₄ x 13 ¹ / ₄	5 ⁵ / ₈	6 ¹ / ₈
Landmark Solaris	Laminated (Metric)	Peachtree, GA; Portland, OR; Wilmington, CA	PT, PO, WI	38 ³ / ₄ x 13 ¹ / ₄	5 ⁵ / ₈	6 ¹ / ₈
Landmark Solaris Gold/Platinum	Laminated (Metric)	Portland, OR	PO	38 ³ / ₄ x 13 ¹ / ₄	5 ⁵ / ₈	6 ¹ / ₈
Landmark Solaris IR	Laminated (Metric) Impact Resistant	Peachtree, GA	PT	38 ³ / ₄ x 13 ¹ / ₄	5 ⁵ / ₈	6 ¹ / ₈
Landmark Pro	Laminated (Metric)	Avery, OH; Jonesburg, MO; Norwood, MA; Oxford, NC; Peachtree City, GA; Portland, OR; Shakopee, MN; Shreveport, LA; Wilmington, CA	AV, JB, NW, OX, PT, PO, SH, SP, WI	38 ³ / ₄ x 13 ¹ / ₄	5 ⁵ / ₈	6 ¹ / ₈
Landmark Pro Solaris	Laminated (Metric)	Wilmington, CA	WI	38 ³ / ₄ x 13 ¹ / ₄	5 ⁵ / ₈	6 ¹ / ₈
Landmark IR	Laminated (Metric) Impact Resistant	Shreveport, LA	SP	38 ³ / ₄ x 13 ¹ / ₄	5 ⁵ / ₈	6 ¹ / ₈
Landmark	Laminated (Metric)	Avery, OH; Ennis, Texas; Jonesburg, MO; Norwood, MA; Oxford, NC; Peachtree City, GA; Portland, OR; Shakopee, MN; Shreveport, LA; Wilmington, CA;	AV, EN, JB, NW, OX, PT, PO, SH, SP, WI,	38 ³ / ₄ x 13 ¹ / ₄	5 ⁵ / ₈	6 ¹ / ₈
XT-30	3-Tab (Metric)	Portland, OR	PO	39 ³ / ₈ x 13 ¹ / ₄	5 ⁵ / ₈	6 ¹ / ₈
XT-30	3-Tab (Standard)	Avery, OH; Norwood, MA; Oxford, NC; Shakopee, MN;	AV, NW, OX, SH	36 x 12	5	5 ⁵ / ₈
XT-30 IR	3-Tab (Standard) Impact Resistant	Shreveport, LA	SP	36 x 12	5	5 ⁵ / ₈
XT-25	3-Tab (Metric)	Avery, OH Portland, OR	AV PO	39 ³ / ₈ x 13 ¹ / ₄	5 ⁵ / ₈	6 ¹ / ₈
XT-25	3-Tab (Standard)	Avery, OH; Norwood, MA; Oxford, NC; Shakopee, MN; Shreveport, LA	AV, NW, OX, SH, SP	36 x 12	5	5 ⁵ / ₈
CT-20	3-Tab (Metric)	Portland, OR	PO	39 ³ / ₈ x 13 ¹ / ₄	5 ⁵ / ₈	6 ¹ / ₈

TABLE 1—PRODUCT DESCRIPTIONS AND MANUFACTURING LOCATIONS (Continued)

PRODUCTS	SHINGLE TYPE	PLANT LOCATION	PLANT DESIGNATION	DIMENSIONS (width x height) (inches)	MAXIMUM EXPOSURE TO THE WEATHER (inches)	LOCATION OF NAIL "LINE" (distance above shingle butt) (inches)
CT-20	3-Tab (Standard)	Oxford, NC; Shreveport, LA	OX, SP	36 x 12	5	5 ⁵ / ₈
Landmark Pro Architect 80	Laminated (Metric)	Portland, OR	PO	38 ³ / ₄ x 13 ¹ / ₄	5 ⁵ / ₈	6 ¹ / ₈
Independence	3-Tab Laminated (Standard)	Avery, OH; Oxford, NC; Shakopee, MN	AV, OX, SH	36 x 12	5	5 ⁵ / ₈
Hatteras	4-Tab	Oxford, NC	OX	36 x 18	8	9 ³ / ₈
Highland Slate	4-Tab	Oxford, NC	OX	36 x 18	8	9 ³ / ₈
Highland Slate IR	4-Tab Impact Resistant	Oxford, NC	OX	36 x 18	8	9 ³ / ₈
Patriot	No Cut-out	Avery, OH, Norwood, MA, Portland, OR	AV, NW PO	39 ³ / ₈ x 13 ¹ / ₄	5 ⁵ / ₈	6 ¹ / ₈
NorthGate	Laminated (Metric)	Portland, OR; Shakopee, MN	PO, SH	39 ³ / ₄ x 13 ¹ / ₄	5 ⁵ / ₈	6 ¹ / ₈
Arcadia Shake	4-Layer Laminated	Fremont, CA	FR	37 ¹ / ₂ x 19 ¹ / ₂ ³	8 ¹ / ₂	9
Belmont	4-Tab Laminated	Oxford, NC	OX	36 x 18	8	8 ⁵ / ₈
Belmont IR	4-Tab Laminated Impact Resistant	Oxford, NC	OX	36 x 18	8	8 ⁵ / ₈
ACCESSORY PRODUCTS (See Note 1)						
Shangle Ridge	Hip and Ridge	Oxford, NC	OX	12 x 18	8	8 ⁵ / ₈
Cedar Crest	Hip and Ridge	Oxford, NC	OX	12 x 18	8	8 ⁵ / ₈
Cedar Crest IR	Hip and Ridge Impact Resistant	Oxford, NC	OX	12 x 18	8	8 ⁵ / ₈
Mountain Ridge	Hip and Ridge	Fremont, CA	FR	8 x 12 & 10 x 12	8	8 ⁵ / ₈
Shadow Ridge	Hip and Ridge (Standard)	Avery, OH; Norwood, MA; Oxford, NC; Shakopee, MN	AV, NW, OX, SH	12 x 12	5	5 ⁵ / ₈
Shadow Ridge	Hip and Ridge (Metric)	Portland, OR	PO	9.84 x 13 ¹ / ₄	5 ⁵ / ₈	6 ¹ / ₈
Solaris Hip and Ridge Accessory	Hip and Ridge	Portland, OR	PO	9.84 x 13 ¹ / ₄	5 ⁵ / ₈	6 ¹ / ₈
Solaris Accessory	Hip and Ridge	Portland, OR	PO	13 ¹ / ₈ x 13 ¹ / ₄	5 ⁵ / ₈	6 ¹ / ₈
Solaris Accessory IR	Hip and Ridge	Portland, OR	PO	13 ¹ / ₈ x 13 ¹ / ₄	5 ⁵ / ₈	6 ¹ / ₈
NorthGate Ridge	Hip and Ridge	Portland, OR	PO	9 ⁷ / ₈ x 13 ¹ / ₄	5 ⁵ / ₈	6 ¹ / ₈
NorthGate Accessory	Hip and Ridge	Shakopee, MN	SH	12 x 12	5	5 ⁵ / ₈
Presidential Starter	Starter Shingle	Fremont, CA Portland, OR	FR, PO	40 x 13 ¹ / ₄ , bottom layer; 40 x 11 ¹ / ₄ , top layer	4 (top layer)	4 (bottom layer) 6 (top layer)
Presidential Starter IR	Starter Shingle	Fremont, CA	FR	40 x 13 ¹ / ₄ , bottom layer; 40 x 11 ¹ / ₄ , top layer	4 (top layer)	4 (bottom layer) 6 (top layer)
High Performance Starter	Starter Shingle	Oxford, NC	OX	36 x 10	n/a	max 3, or into solid wood
Swiftstart	Starter Shingle	Shakopee, MN	SH	38 ³ / ₄ x 7 ⁵ / ₈	n/a	max 3, or into solid wood
Universal Starter	Starter Shingle	Avery, OH; Oxford, NC; Shakopee, MN; Shreveport, LA	AV, OX, SH, SP	36 x 7	n/a	max 3, or into solid wood

For SI: 1 inch = 25.4 mm; 1 lb/100 ft² = 0.0488 kg/m².

NOTES:

1. Includes algae-resistant (AR) versions.
2. Nail "Line" - Distance from lowermost lowest edge of shingle to target nail location.
3. Shingle butt location varies up to 1-inch. Dimensions shown for shingle height and nail "line" location are averages.

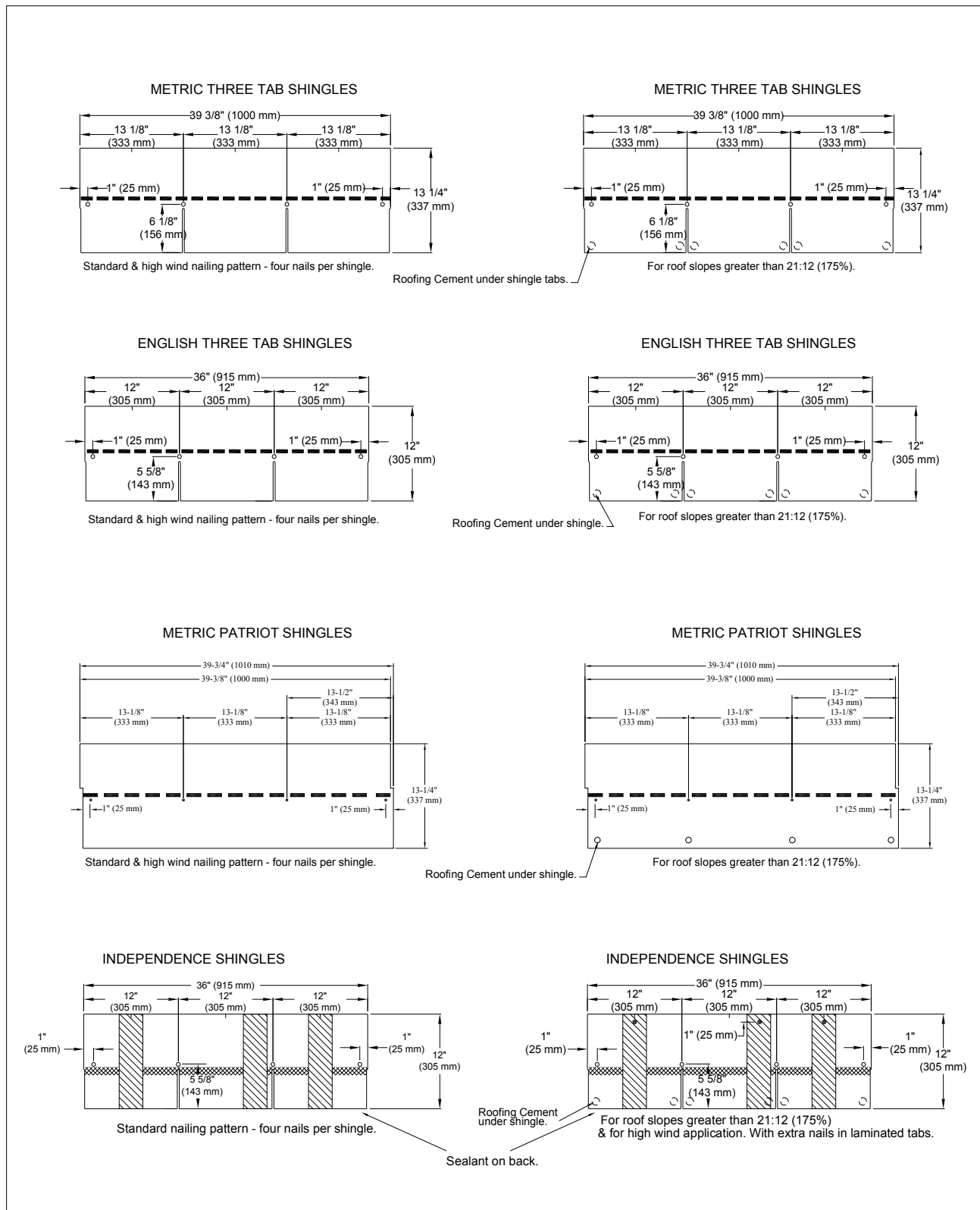

FIGURE 1—SHINGLE PROFILES AND FASTENER PATTERNS

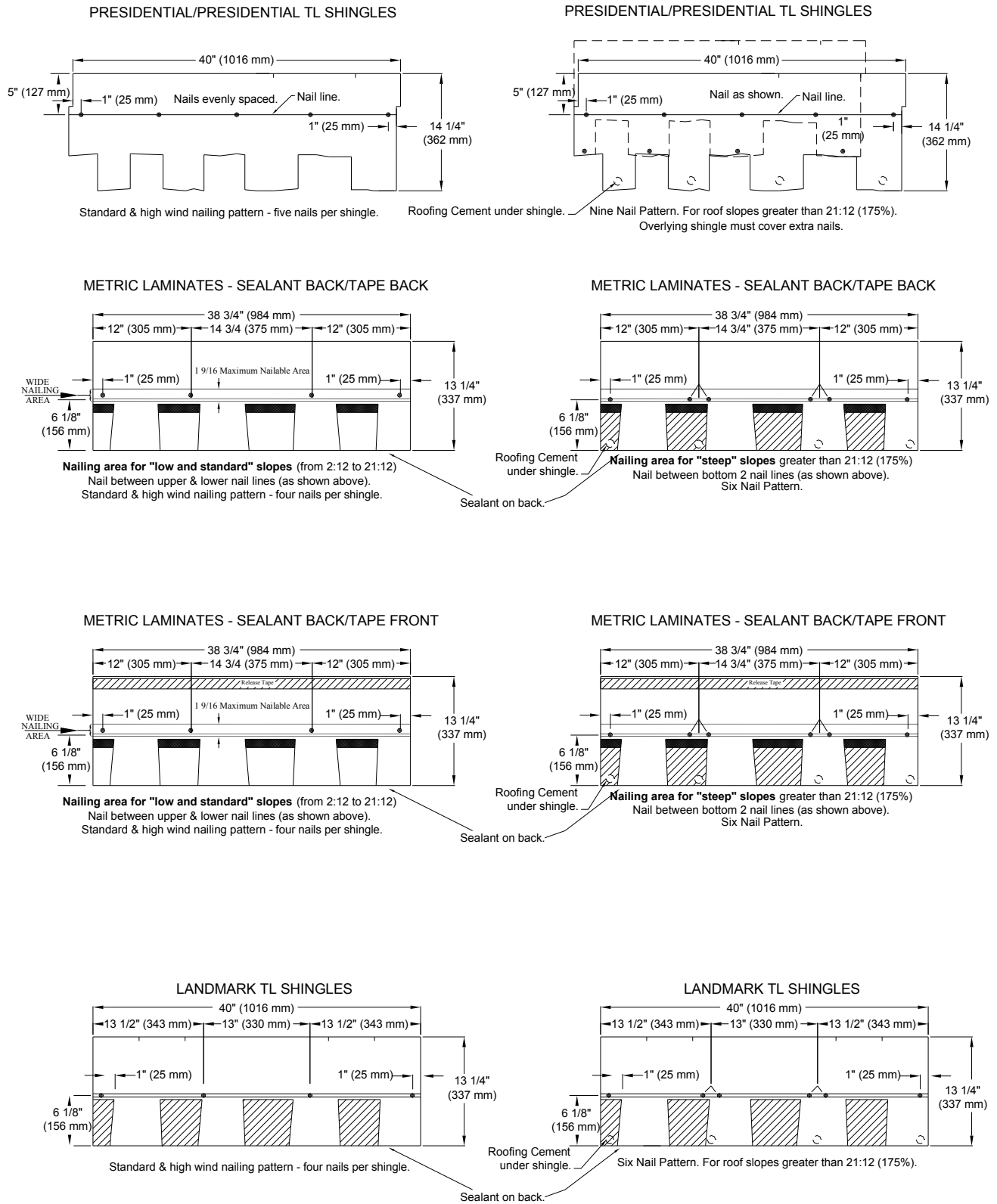

FIGURE 1—SHINGLE PROFILES AND FASTENER PATTERNS (Continued)

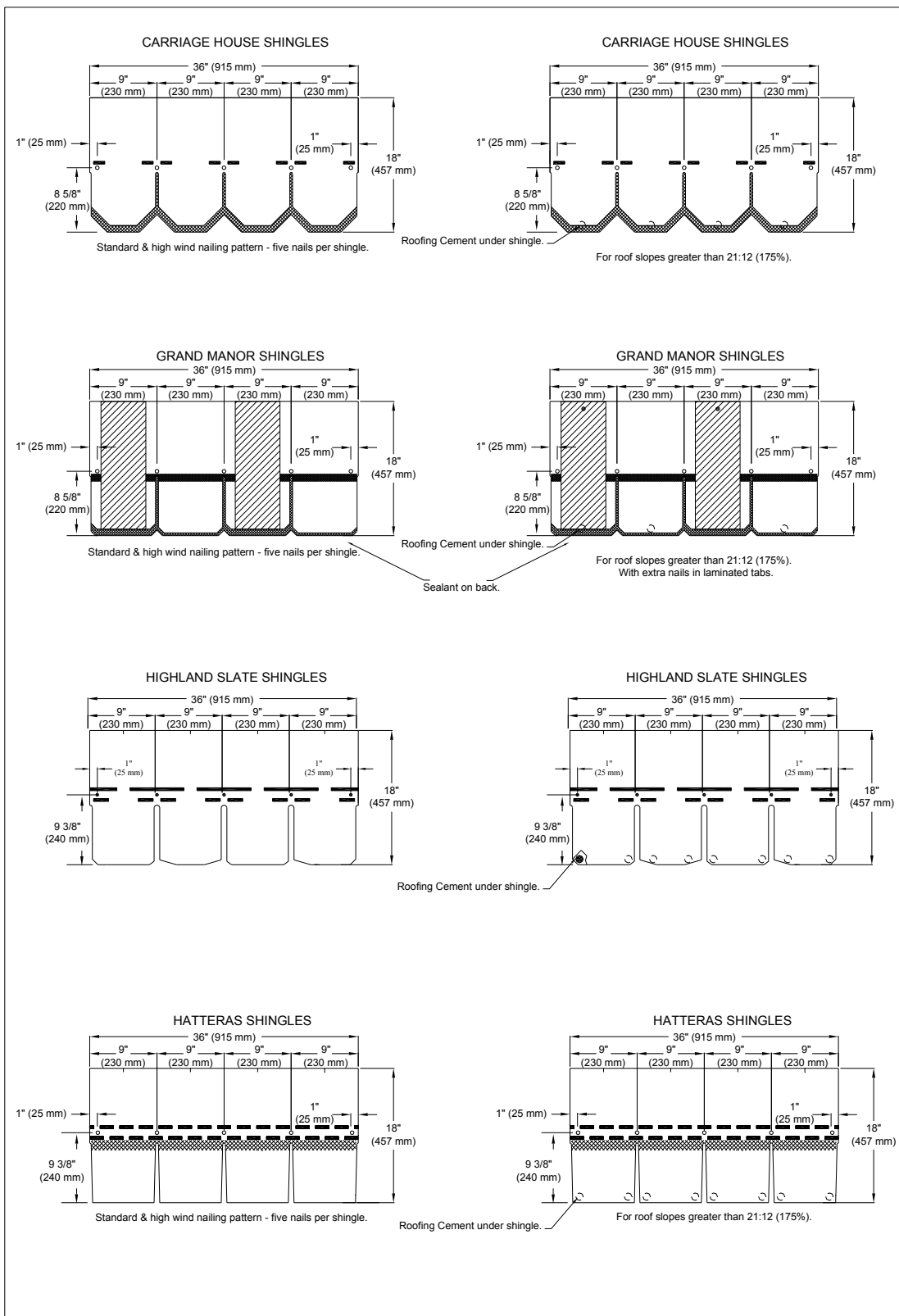

FIGURE 1—SHINGLE PROFILES AND FASTENER PATTERNS (Continued)

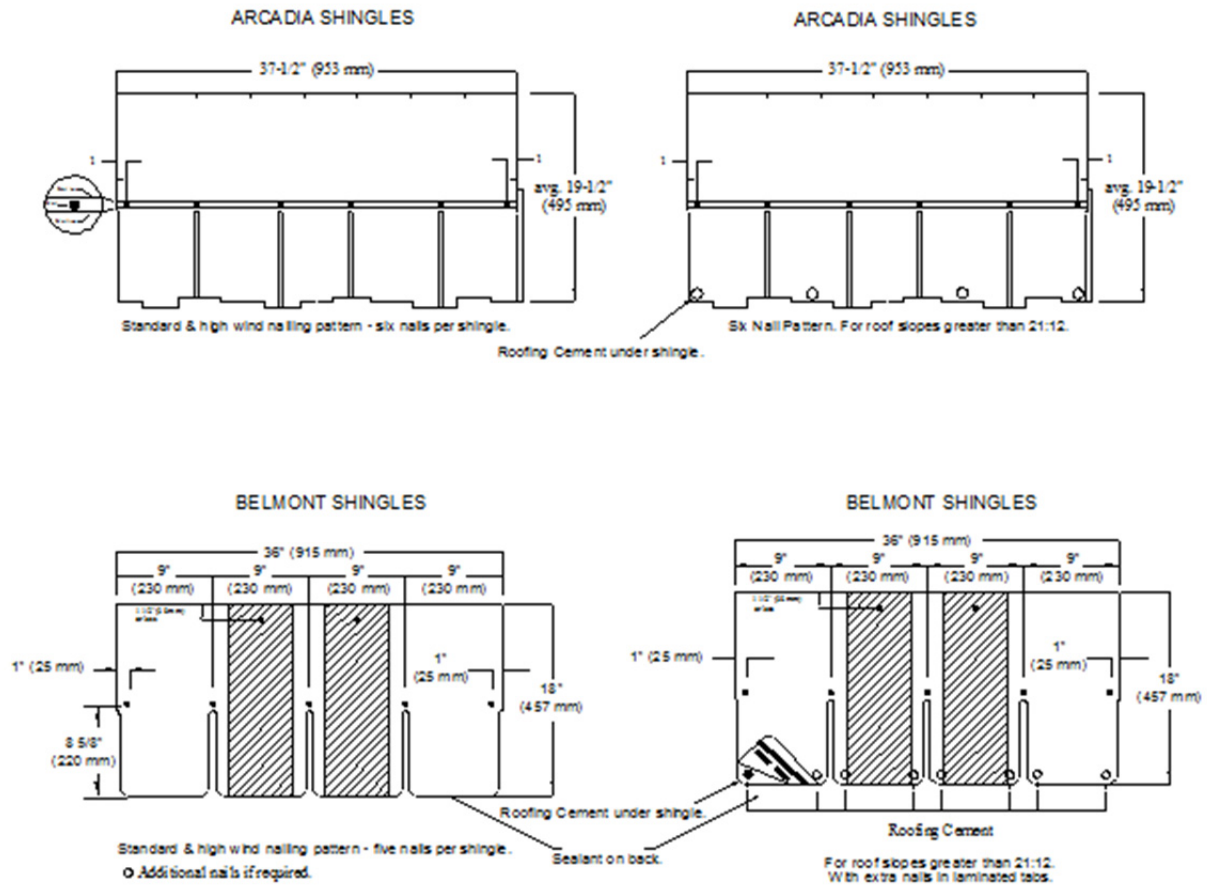
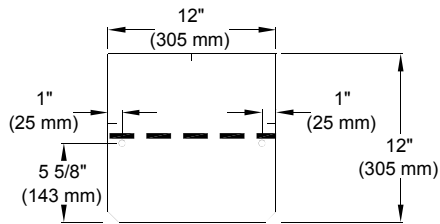

FIGURE 1—SHINGLE PROFILES AND FASTENER PATTERNS (Continued)

**ENGLISH
NORTHGATE ACCESSORY & SHADOW
RIDGE SHINGLES**



Nailing pattern all applications - two nails per shingle.

SHANGLE RIDGE SHINGLES

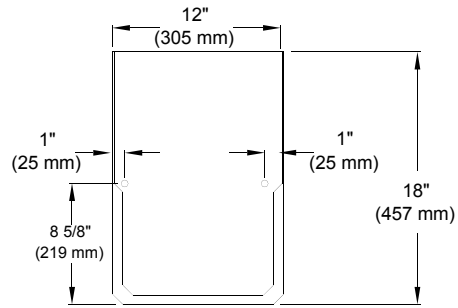

Nailing pattern all applications - two nails per shingle.

**METRIC
NORTHGATE RIDGE, SHADOW RIDGE,
SOLARIS HIP & RIDGE ACCESSORY
SHINGLES**

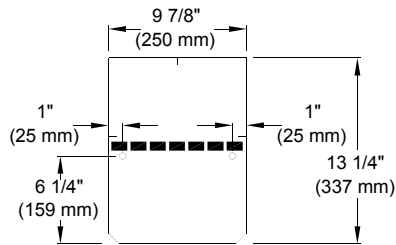

Nailing pattern all applications - two nails per shingle.

**METRIC
SOLARIS ACCESSORY
SHINGLES**

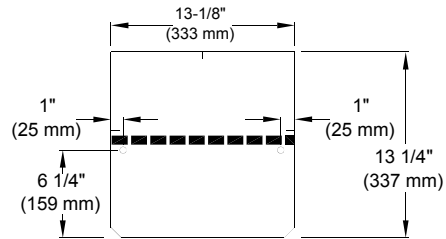

Nailing pattern all applications - two nails per shingle.

**10"
MOUNTAIN RIDGE SHINGLES**

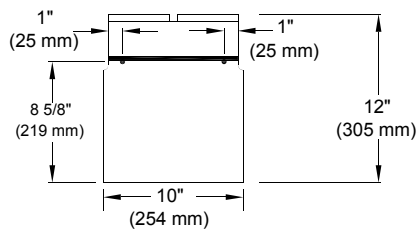

Nailing pattern all applications - two nails per shingle.

**8"
MOUNTAIN RIDGE SHINGLES**

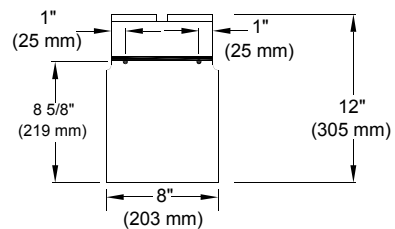

Nailing pattern all applications - two nails per shingle.

FIGURE 1—SHINGLE PROFILES AND FASTENER PATTERNS (Continued)

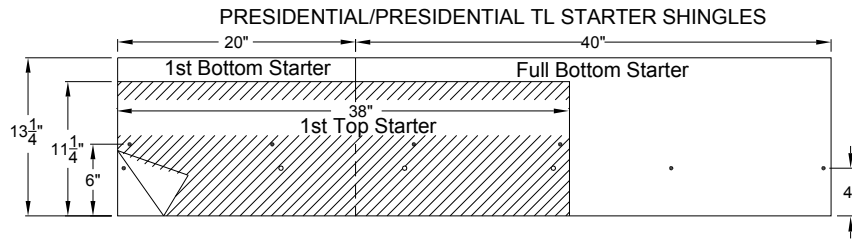

Standard nailing pattern for all slopes from 2/12 (16.7%) up to and exceeding 21/12 (175%) & for high wind application.

SWIFTSTART SHINGLES

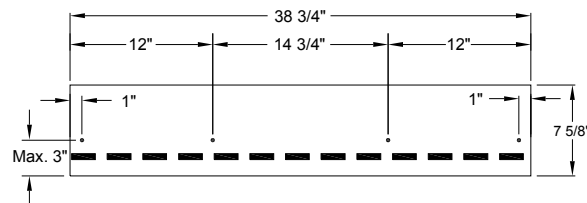

Standard nailing pattern for all slopes from 2/12 (16.7%) up to and exceeding 21/12 (175%) & for high wind application.

UNIVERSAL STARTER SHINGLES

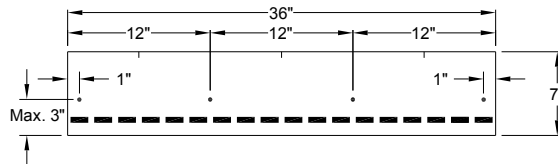

Standard nailing pattern for all slopes from 2/12 (16.7%) up to and exceeding 21/12 (175%) & for high wind application.

HIGH-PERFORMANCE STARTER SHINGLES

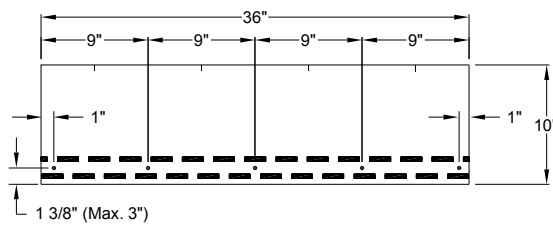

Standard nailing pattern for all slopes from 2/12 (16.7%) up to and exceeding 21/12 (175%) & for high wind application.

FIGURE 1—SHINGLE PROFILES AND FASTENER PATTERNS (Continued)