

Techstyle® Texture panels capture the appearance of stone, leather, stucco, and plaster, each available in an unlimited array of hues.

Project: Dejoria Center, Kamas, UT; Techstyle® Texture – Buckskin – Custom

KEY FEATURES

- Proprietary formaldehyde-free fiberglass composite construction
- Monolithic appearance - large format panels, semi-concealed suspension, nominal 1/4" reveals
- Convenient swing-down access to the plenum
- Trims are engineered for fast installation of Techstyle®
- Lighting and diffuser integration
- Enhanced soiling resistance and clean-ability
- Class A Fire Rating, per ASTM E84
- GREENGUARD Gold Certified

PHYSICAL DATA

Surface Finish: Non-woven
Light Reflectance: 81% (LR1) ASTM E1477
Surface Burning: Class A (ASTM E84)
 – Flame Spread Index \leq 25
 – Smoke Index \leq 50
Acoustical Ratings – NRC: 0.85 (ASTM C 423)
Acoustical Ratings – CAC: 17 w/no backer, (ASTM E1414)
Moisture Resistance: Resistant to 95% humidity in 104° temperature
Fungal Resistance: Resistant (ASTM C1338)
Weight: 0.30 lbs. per sq. ft.
Warranty: 10 year limited
ICC: Approval (ESR-2123)

BIM

REVIT files available for BIM contributions, see website for details.

TYPICAL ISOMETRIC

Echelon™ grid system with swing down panels

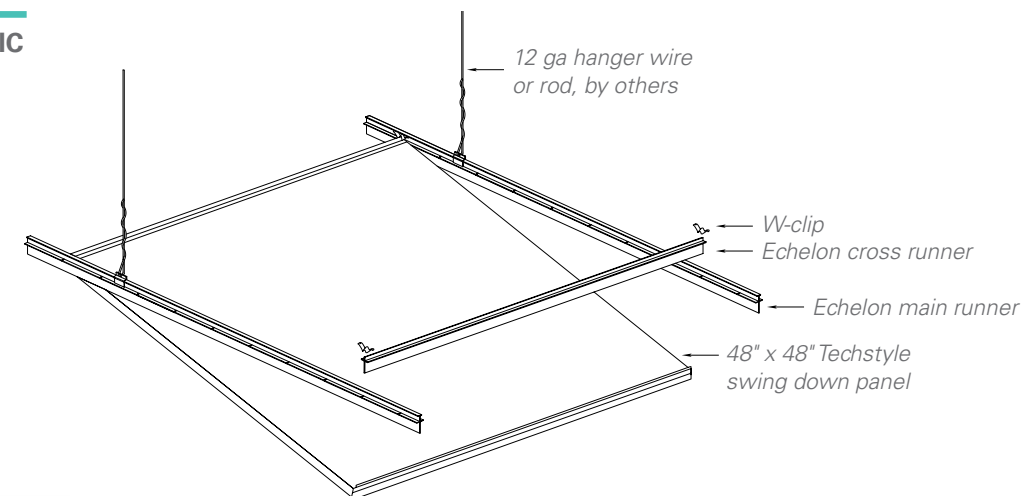

SUSPENSION SYSTEMS

Echelon: CertainTeed grid system
 Compatible with swing down and lay-in panels

Swing Down Panels
 15/16" T-Grid

Lay-in Panels
 15/16" T-Grid or 9/16" T-Grid

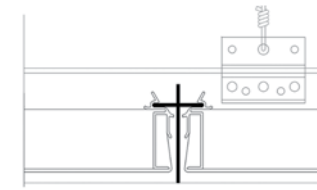

ECHELON™

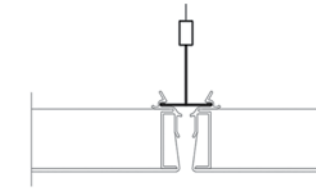

SWING DOWN

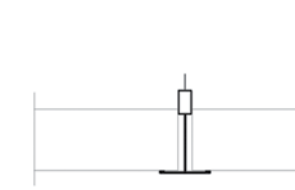

LAY-IN

PANEL SIZES

Additional sizes available, consult manufacturer.

SWING-DOWN

Width x Length

24" x 6"	24" x 24"	24" x 42"	24" x 48"	24" x 54"	24" x 60"
24" x 66"	24" x 72"	24" x 78"	24" x 84"	24" x 90"	24" x 96"
30" x 6"	30" x 30"	30" x 60"	30" x 72"	30" x 96"	
48" x 6"	48" x 24"	48" x 42"	48" x 48"	48" x 54"	48" x 60"
48" x 66"	48" x 72"				

LAY-IN

Width x Length

24" x 6"	24" x 24"	24" x 42"	24" x 48"	24" x 54"	24" x 60"	24" x 66"
24" x 72"	24" x 78"	24" x 84"	24" x 90"	24" x 96"	24" x 120"	
30" x 6"	30" x 30"	30" x 60"	30" x 72"	30" x 96"		
48" x 6"	48" x 24"	48" x 42"	48" x 48"	48" x 54"	48" x 60"	48" x 66"
48" x 72"	48" x 96"					

TYPICAL SECTION – TRIMS

See Resource section for available trim options.

ACOUSTICS

Techstyle®'s honeycomb design absorbs both high and low frequencies at an impressive level, providing superior acoustical performance, no matter the frequency. NRC 0.85 (ASTM C 423) SAA 0.86 (ASTM C 423).

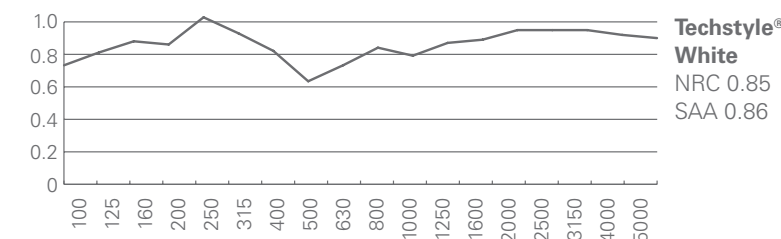

LEED V4 CREDITS

- EA: Optimize Energy Performance
- MR: Building Product Disclosure
- EQ: Low-Emitting Materials
- EQ: Indoor Air Quality Assessment
- EQ: Daylight
- EQ: Acoustic Performance

CERTIFICATIONS

GREENGUARD Gold Certified

TEXTURES

Textures are available in all patterns below; custom patterns are also available. Minimum quantities may apply. Colors are for illustrative purposes only.

BRUSHED – BOX OFFICE

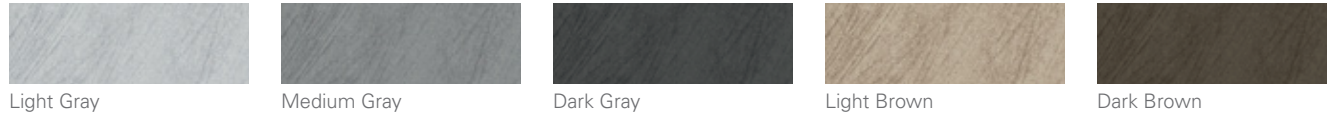

CONCRETE



HAMPTON OAK

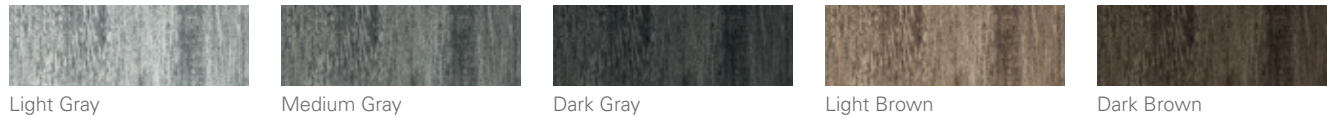

LEATHER – BUCKSKIN



LEATHER – GOTAN

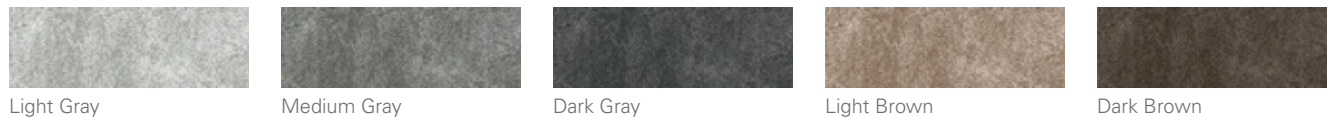

MODIGLIAMI

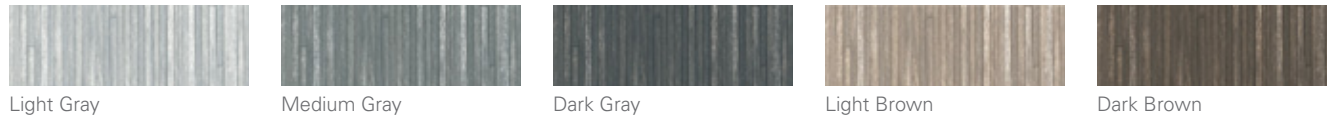

OLIVE LUNGO

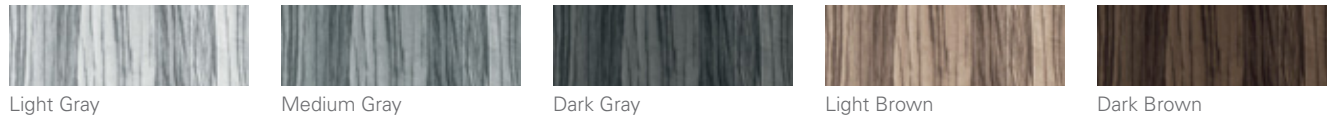

PAINTED WOOD

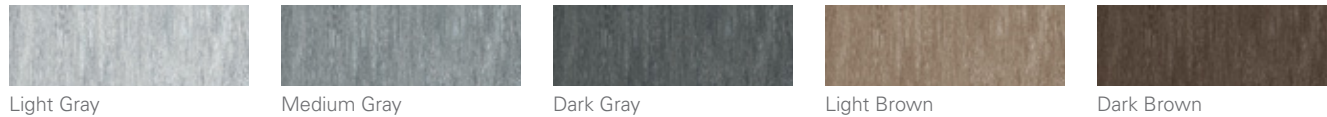

SANTOS PALISANDE

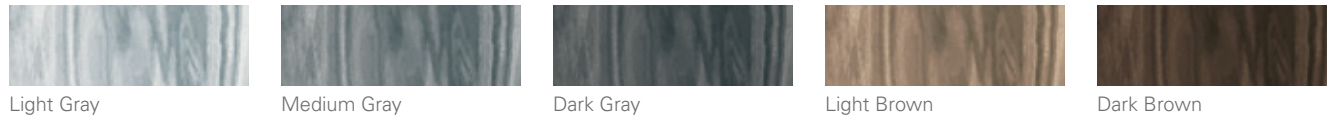

TEXTURED – CARRICK

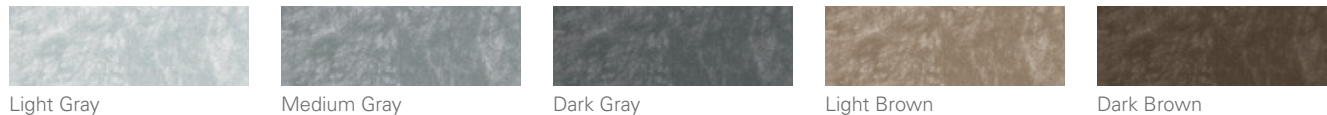

Project: Heartland Acoustics, Englewood, CO; Techstyle® Texture – Concrete – Medium Gray Photo Credit: Kara Kelley