

Techstyle® Color delivers both sound and vision, combining acoustical performance with an extensive palette, including hues from major paint manufacturers.

Project: National Interstate Insurance Company Headquarters, Richfield, OH; Techstyle® Color – Custom Color Photo credit: Studio 66 LLC

### KEY FEATURES

- Proprietary formaldehyde-free fiberglass composite construction
- Monolithic appearance - large format panels, semi-concealed suspension, nominal 1/4" reveals
- Convenient swing-down access to the plenum
- Trims are engineered for fast installation of Techstyle®
- Lighting and diffuser integration
- Enhanced soiling resistance and clean-ability
- Class A Fire Rating, per ASTM E84
- GREENGUARD Gold Certified

### PHYSICAL DATA

**Surface Finish:** Non-woven  
**Light Reflectance:** 81% (LR1) ASTM E1477  
**Surface Burning:** Class A (ASTM E84)  
 – Flame Spread Index ≤ 25  
 – Smoke Index ≤ 50  
**Acoustical Ratings – NRC:** 0.85 (ASTM C 423)  
**Acoustical Ratings – CAC:** 17 w/no backer, (ASTM E1414)  
**Moisture Resistance:** Resistant to 95% humidity in 104° temperature  
**Fungal Resistance:** Resistant (ASTM C1338)  
**Weight:** 0.30 lbs. per sq. ft.  
**Warranty:** 10 year limited  
**ICC:** Approval (ESR-2123)

### BIM

REVIT files available for BIM contributions, see website for details.

### TYPICAL ISOMETRIC

Echelon™ grid system with swing down panels

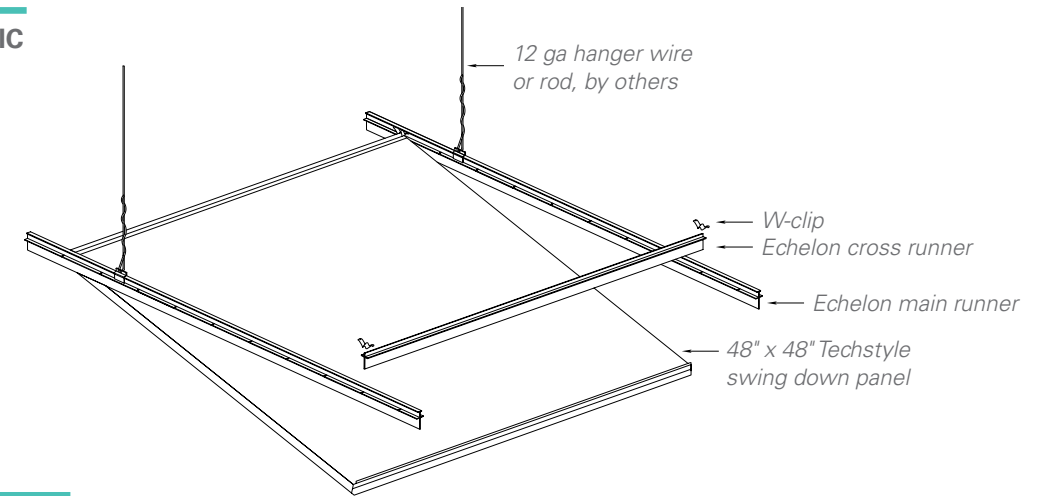

### SUSPENSION SYSTEMS

Echelon: CertainTeed grid system  
 Compatible with swing down and lay-in panels

Swing Down Panels  
 15/16" T-Grid

Lay-in Panels  
 15/16" T-Grid or 9/16" T-Grid

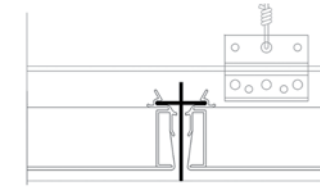

ECHELON™

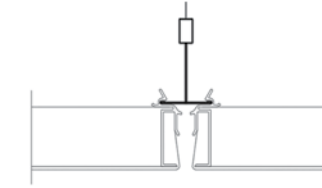

SWING DOWN

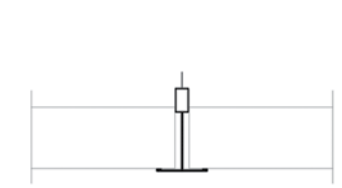

LAY-IN

### PANEL SIZES

Additional sizes available, consult manufacturer.

#### SWING-DOWN

Width x Length

24" x 6"	24" x 24"	24" x 42"	24" x 48"	24" x 54"	24" x 60"
24" x 66"	24" x 72"	24" x 78"	24" x 84"	24" x 90"	24" x 96"
30" x 6"	30" x 30"	30" x 60"	30" x 72"	30" x 96"	
48" x 6"	48" x 24"	48" x 42"	48" x 48"	48" x 54"	48" x 60"
48" x 66"	48" x 72"				

#### LAY-IN

Width x Length

24" x 6"	24" x 24"	24" x 42"	24" x 48"	24" x 54"	24" x 60"	24" x 66"
24" x 72"	24" x 78"	24" x 84"	24" x 90"	24" x 96"	24" x 120"	
30" x 6"	30" x 30"	30" x 60"	30" x 72"	30" x 96"		
48" x 6"	48" x 24"	48" x 42"	48" x 48"	48" x 54"	48" x 60"	48" x 66"
48" x 72"	48" x 96"					

### TYPICAL SECTION – TRIMS

See Resource section for available trim options.

### ACOUSTICS

Techstyle®'s honeycomb design absorbs both high and low frequencies at an impressive level, providing superior acoustical performance, no matter the frequency. NRC 0.85 (ASTM C 423) SAA 0.86 (ASTM C 423).

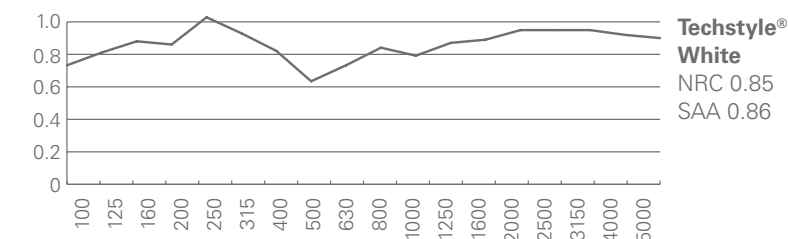

### LEED V4 CREDITS

- EA: Optimize Energy Performance
- MR: Building Product Disclosure
- EQ: Low-Emitting Materials
- EQ: Indoor Air Quality Assessment
- EQ: Daylight
- EQ: Acoustic Performance

### CERTIFICATIONS

GREENGUARD Gold Certified

TECHSTYLE® CEILINGS

TECHSTYLE® COLOR

**COLORS**

Client specific colors available. Minimum quantities may apply. Colors are for illustrative purposes only.

**LATTE**



Latte – 100



Latte – 80



Latte – 60

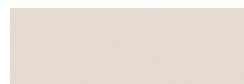

Latte – 40

**FOOTHILLS**



Foothills – 100



Foothills – 80



Foothills – 60



Foothills – 40

**STERLING**

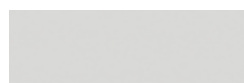

Sterling – 100



Sterling – 80



Sterling – 60

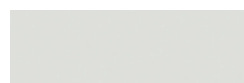

Sterling – 40

**SEAGRASS**



Seagrass – 100



Seagrass – 80



Seagrass – 60

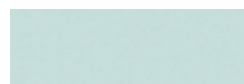

Seagrass – 40

**CONCRETE**



Concrete – 100



Concrete – 80



Concrete – 60



Concrete – 40

**STORM**



Storm – 100



Storm – 80



Storm – 60



Storm – 40

**COAL**



Coal – 100



Coal – 80



Coal – 60



Coal – 40

**PENNY**



Penny – 100



Penny – 80



Penny – 60



Penny – 40

**CUSTOM COLORS**

Panels can be matched to solid colors from major paint manufacturers.



Project: National Interstate Insurance Company Headquarters, Richfield, OH; Techstyle® Color – Custom Color Photo credit: Studio 66 LLC