

# TECHNICAL BULLETINS

## TABLE OF CONTENTS

FlintBoard® Roof Insulation Application

Flintlastic® SA Low-Slope Substrate Guidelines

Self-Adhered Flintlastic® SA Cap Sheet Competitive Audit

Self-Adhered Wind Uplift Performance Comparison

Staining

Woodblocking

Wind Uplift Resistance

# TECHNICAL BULLETIN

## FLINTBOARD® ROOF INSULATION APPLICATION UPDATE

### **MULTI-LAYERING OF ROOF INSULATION**

**CertainTeed supports the industry standard recommendation for multiple layers of roof insulation** installed with offset (staggered) joints. The purpose of such practice is the elimination of thermal bridging, prevention of thermal loss at insulation joints, reduction of moisture migration into the roof system and reduction of membrane splitting, all benefits provided by multiple layers of roof insulation. In other words, a single-layer application can contribute to loss of design thermal value, moisture migration into the roof system and ridging or splitting of the roof membrane. The benefits of multiple layers of rigid board insulation of all types have been well known for years. Industry authorities, including NRCA and ORNL, have recognized these benefits and many have followed the long-standing recommendation for the use of multiple insulation layers. Unfortunately, reports from the field indicate that single-layered applications are still commonplace. Therefore, we are formalizing our requirements within this technical bulletin.

### **HOT-APPLIED BUR AND MODIFIED BITUMINOUS ROOF SYSTEMS**

Although coverboards are generally required for hot-applied BUR and modified bituminous systems and do create a multi-layered insulation system, multiple layers of FlintBoard® installed with staggered joints beneath the coverboard can further improve the thermal performance of the roof system.

### **BOTTOM LAYER MECHANICALLY FASTENED WITH SUCCESSIVE LAYERS MOPPED**

When a coverboard in an approved assembly is used, any thickness equal to or greater than 1.5" is acceptable. However, thermal efficiency may be increased by the use of multiple layers of FlintBoard. When the total required polyiso insulation thickness is equal to or greater than 3" thickness, the minimum recommended thickness is 1.5" for both the bottom and top layer. Please refer to our published LTTR-value/thickness chart to ensure that the required thermal value is provided.

The joints of each layer must be offset (staggered) to prevent continuous vertical joints through the full insulation thickness.

### **CONSTRUCTION-GENERATED MOISTURE**

Cold weather often dictates that the shell or building envelope be substantially closed before interior work can proceed. In other words, exterior walls and roofs are sometimes constructed before the concrete floor slab is placed or other moisture-producing activities begin. At this point, heaters, which also produce large quantities of moisture, are often employed to provide more comfortable working conditions and to assist in drying the construction. Since the building is basically closed, adequate ventilation is often unavailable to prevent these large quantities of moisture from entering the roof system. In addition, loose-laid or partially attached roof systems may promote air leakage, drawing

# TECHNICAL BULLETIN

## FLINTBOARD® ROOF INSULATION APPLICATION UPDATE

moisture-laden air up from the building interior. These levels of moisture are well known and well documented. (See NRCA Roofing and Waterproofing Manual, The Manual of Low-Slope Roof Systems [Griffith and Fricklas], and Roofs [Baker]).

In the absence of adequate ventilation, a vapor/air retarder is recommended to limit the movement of moisture into the roof system. ***Therefore, CertainTeed cannot assume responsibility for the performance of FlintBoard roof insulation when installed under these high moisture conditions unless a properly installed, effective vapor/air retarder is present. Location of the vapor/air retarder within the roof system is the responsibility of the designer.***

The inclusion of a vapor/air retarder may affect insulation fastening requirements, wind uplift ratings or other approvals.

Consult the roof system manufacturer for fastening and approval requirements when insulation is placed over a vapor/air retarder.

### COVERBOARDS

The use of coverboards (e.g., high-density wood fiber or perlite) over a base layer of insulation creates a multi-layered application and has long been standard practice in hot-applied BUR and modified bituminous systems. Some industry experts, contractor organizations, consultants and specifiers also recommend the use of a coverboard in single-ply applications, especially in fully adhered systems, because it protects the foam/facer interface from traffic and certain adhesive solvents.

***The roof system designer or the manufacturer that issues the roof or roof system warranty, should be consulted for coverboard requirements and approvals.***

When construction traffic or material storage is expected on the finished roof, CertainTeed **recommends** that a coverboard or other adequate protection, such as plywood, be placed over the finished roof. The placement of an adequate protective layer over the finished roof system should also protect the membrane from damage and is normally recommended by the roof system manufacturer. The coverboard should possess higher compression resistance than the base layer to help distribute loads caused by construction and frequent maintenance traffic. **In the absence of adequate protection, CertainTeed cannot assume responsibility for foam crushing, facer/foam separation or other forms of damage.**

### COLD-WEATHER APPLICATIONS

Millions of square feet of roofing have been successfully installed in cold weather, but it does present the contractor with difficult installation conditions that require special care and modified techniques to ensure a trouble-free installation. For example, cold weather may require shorter mop leads to avoid the rapid cooling of asphalt before insulation or membranes are placed. Sealants are also affected by cold weather and should be maintained above the manufacturer's recommended minimum application temperature.

Similarly, materials used in single-ply systems, especially adhesives used in fully adhered systems, are temperature-sensitive, requiring careful attention during application. For example, adhesive drying time (open time) can be significantly increased in the presence of low temperatures and high humidity, conditions that are common during portions of the fall, winter and spring in certain regions of North America. Membranes should also be allowed to relax before they are applied.

# TECHNICAL BULLETIN

## FLINTBOARD® ROOF INSULATION APPLICATION UPDATE

**Improperly applied membrane or adhesive may affect membrane-to-insulation bond strength, as well as facer-to-foam bond strength or foam cohesive strength near the facer in polyiso roof insulation. CertainTeed makes the following recommendations:**

First, without fail, the roof membrane system manufacturer's recommendations should be followed carefully, including adhesive application and membrane relaxation guidelines. Consultation with the membrane system manufacturer prior to installation, especially in cold weather, is recommended.

Adhesives should be maintained at temperatures above the membrane manufacturer's recommended minimum temperature at the point of application. Heated on site storage areas and rooftop hot boxes may be necessary.

Materials to receive adhesive application should also be maintained at temperatures warm enough to prevent rapid cooling of the adhesive as it is applied.

Special care should be taken to allow solvents in adhesives to evaporate (flash off) in accordance with the membrane manufacturer's recommendations. The difference in drying rates between shaded and sunlit areas should be considered. When the membrane is placed over insufficiently dried adhesive, the solvents may be trapped and forced downward into the insulation.

***CERTAINTEED HEREBY EXPRESSLY DISCLAIMS ANY AND ALL REPRESENTATIONS AND WARRANTIES REGARDING FLINTBOARD, EXPRESS OR IMPLIED, INCLUDING, WITHOUT LIMITATION, THE IMPLIED WARRANTIES OF MERCHANTABILITY AND FITNESS FOR A PARTICULAR PURPOSE. IN NO EVENT SHALL CERTAINTEED BE LIABLE FOR CONSEQUENTIAL OR INCIDENTAL DAMAGES OF ANY KIND. SOME STATES DO NOT ALLOW EXCLUSIONS OR LIMITATIONS OF INCIDENTAL OR CONSEQUENTIAL DAMAGES, SO THE ABOVE LIMITATIONS AND EXCLUSIONS MAY NOT APPLY TO YOU.***



**CertainTeed**

CEILINGS • DECKING • FENCE • GYPSUM • INSULATION • RAILING • ROOFING • SIDING • TRIM

20 Moores Road Malvern, PA 19355 Professional: 800-233-8990 Consumer: 800-782-8777 [certainteed.com](http://certainteed.com)

© 01/20 CertainTeed, Printed in the USA

# TECHNICAL BULLETIN

## FLINTLASTIC® SA LOW-SLOPE SUBSTRATE GUIDELINES

Date: 1/1/2020

Supersedes: 4/1/2019

Guidelines for acceptable substrates for CertainTeed LLC's Flintlastic® SA self-adhered SBS modified bitumen roll goods (Flintlastic SA PlyBase, SA MidPly, SA Cap (FR) are as follows:

### BASE SHEETS

- Flintlastic SA NailBase
- Flintlastic SA PlyBase
- Flintlastic SA MidPly

### INSULATION

- FlintBoard® ISO & ISO Cold (polyisocyanurate insulation)

### COVER BOARD

- High density fiberboard (ASTM C208 & 209 - primed boards only)
  - i.e. STRUCTODEK® High Density Fiberboard with Primed Red Coating
- Asphalt coated cover boards
- Gypsum based cover board products (priming may be required):
  - USG Securock® Gypsum-Fiber Roof Board
  - Georgia Pacific DensDeck® Roof Boards:
    - DensDeck® (priming is required)
    - DensDeck® Prime (priming is not required but will enhance adhesion)
    - Zip System® Sheathing

### DECKS

- Structural concrete decks\* (priming is required)
  - \*Lightweight Structural Concrete is subject to greater moisture content and not acceptable for direct adherence of Flintlastic SA self-adhering products.
- Wood<sup>1</sup> (priming is required)
  - Approved wood types:
    - APA Rated Exterior Grade Plywood
    - APA Rated Exterior Grade Oriented Strand Board (OSB)
  - Precautions:
    - Direct adhesion is not permitted by code in Miami-Dade County (check your local building code)
    - At the end of the roofing membrane's life, roofing membranes directly adhered to wood roof decks will require replacement of the deck.

If a substrate is not listed above it is not acceptable to install Flintlastic SA products to it and will require the installation of an acceptable substrate first. Consult CertainTeed's Commercial Roofing Technical Services Department with any questions.

Substrates shall be designed and sufficiently rigid to properly support and secure the new roof assembly and shall have proper slope to acceptable water collection devices (i.e. drains, scuppers, gutters, etc). CertainTeed requires a minimum ¼"/12" slope in roof membrane substrates/decks. All substrate surfaces shall be dry, smooth, clean and free of debris, sharp projections and depressions. Any deck openings shall be fully supported on all sides. All penetrations through the deck shall be completed prior to starting the application of the roof system. Installation of conduits or piping above the deck and under the roof membrane is not acceptable and shall not be warranted by CertainTeed.

Surfaces requiring priming should be primed with CertainTeed FlintPrime® or FlintPrime® SA products. CertainTeed FlintBond® is required for use as indicated in the CertainTeed Flintlastic Applicator Manual.

<sup>1</sup>Please refer to reverse side for CertainTeed Flintlastic SA Limited Warranties on wood substrates.

# TECHNICAL BULLETIN

## FLINTLASTIC® SA LOW-SLOPE SUBSTRATE GUIDELINES

Date: 1/1/2020

Supersedes: 4/1/2019

### FLINTLASTIC SA REFERENCE WARRANTY DURATIONS | WOOD ROOF DECKS

Flintlastic SA warranty coverage is offered in varied durations dependent on the type of building, size of project and roof membrane system design.

	Commercial Buildings - Building Owners				Residential Homes - Property Owner/ Occupant <sup>1</sup>			
	Limited Warranty on Materials	Limited Warranty on Systems	NDL Limited Warranty	Full System NDL Limited Warranty	Sure Start	Sure Start Plus, 3 Star	Sure Start Plus, 4 Star	Sure Start Plus, 5 Star
<b>Roof Membrane</b>								
Single-Ply: Flintlastic SA Cap (FR)	12 <sup>2</sup>	--	--	--	10 <sup>3</sup>	--	--	--
Two-Ply: Flintlastic SA NailBase Flintlastic SA Cap (FR) (CoolStar)	--	12						
Two-Ply (with PlyBase): Flintlastic SA PlyBase Flintlastic SA Cap (FR) (CoolStar)	--	15	--	--	15 <sup>4</sup>			
Two-Ply (with MidPly): Flintlastic SA MidPly Flintlastic SA Cap (FR) (CoolStar)	--	20	--	--	--	20 <sup>4</sup>		
Three-Ply (with PlyBase) Flintlastic SA NailBase Flintlastic SA PlyBase Flintlastic SA Cap (FR) (CoolStar)	--	15			--	15 <sup>4</sup>		
Three-Ply (with MidPly) Flintlastic SA NailBase Flintlastic SA MidPly Flintlastic SA Cap (FR) (CoolStar)	--	20			--	20 <sup>4</sup>		

<sup>1</sup> A Property Owner/Occupant must be responsible for the roof in order to qualify for a CertainTeed Residential Warranty.

<sup>2</sup> Warranty is intended for repair projects over existing roof membranes.

<sup>3</sup> Coverage is limited to twenty (20) squares.

<sup>4</sup> Coverage is limited to ten (10) squares.

# TECHNICAL BULLETIN

## FLINTLASTIC® SA LOW-SLOPE SUBSTRATE GUIDELINES

Date: 1/1/2020

Supersedes: 4/1/2019

### WARRANTY COVERAGE | FLINTLASTIC SA | WOOD ROOF DECKS

	Commercial Buildings				Residential Homes			
	Limited Warranty on Materials <sup>1</sup>	Limited Warranty on Systems	NDL Limited Warranty <sup>2</sup>	Full System NDL Limited Warranty <sup>2</sup>	Sure Start <sup>1</sup>	Sure Start Plus, 3 Star	Sure Start Plus, 4 Star	Sure Start Plus, 5 Star
<b>Covers Leaks Caused By:</b>								
Manufacturing Defects:								
CT Roll Goods	x	x	x	x	x	x	x	x
CT Low-Slope Accessories			x	x		x	x	x
CT-Approved Low-Slope Accessories				x		x	x	x
Workmanship			x	x				x
<b>Includes:</b>								
Repair/Replacement – Materials (as Covered)	x	x	x	x	x	x <sup>3</sup>	x <sup>3</sup>	x <sup>3</sup>
Repair/Replacement Labor		x <sup>4</sup>	x	x		x	x	x
Tear-off		x <sup>4</sup>	x	x		x	x	x
Disposal		x <sup>4</sup>	x	x			x	x
Workmanship		x <sup>4</sup>	x	x				x

<sup>1</sup> Coverage is honored when Flintlastic SA products are self-adhered directly to a wood deck. Warranty coverage does not extend to membranes applied to non-ventilated or inadequately ventilated roof deck systems as determined by CertainTeed.

<sup>2</sup> Flintlastic SA NailBase, a nailable anchor sheet, must be applied as the first layer; self-adhering to a wood deck is not warranted.

<sup>3</sup> Coverage duration is roof system dependent

<sup>4</sup> Included only during year one (1) of the warranty

# TECHNICAL BULLETIN

## SELF-ADHERED FLINTLASTIC® SA CAP SHEET COMPETITIVE AUDIT

The objective of an audit is to monitor the products of CertainTeed as well as those of our competitors to determine how well they meet standards of performance set by independent standard-setting authorities such as ASTM (American Society for Testing and Materials). CertainTeed also uses additional tests such as weight, product composition and other comparisons.

In this audit we included CertainTeed's Flintlastic SA Cap, an SBS-modified, polyester reinforced, self-adhered cap sheet and like-products produced by other leading manufacturers. All tests were performed by CertainTeed in a laboratory setting using standard scientific protocol.

Results in the table on right demonstrate:

- Only CertainTeed and one other listed manufacturer are below the ASTM maximum for granule loss.
- Only CertainTeed and one other listed manufacturer are above the ASTM minimum for tensile strength.
- CertainTeed's Flintlastic SA Cap is competitive with or surpasses all other tested products based on the combination of Adhesion, Reinforcement and Backcoating.

### Competitive Audit Summary

	CertainTeed	A	B	C
Roll Weight (lb/sq)	87	91	81	70
Reinforcement	Polyester with fiber-glass scrim	Polyester with fiber-glass strands	Polyester with fiber-glass strands	Fiberglass
Backcoating Asphalt Content (lb/sq)	18	13	15	14
Filler Content in Backcoating (%)	20	24	15	0
Adhesion to Plywood (lb/ft)	24	8	11	34
Adhesion to Base Sheet (lb/ft)	55	42	45	14
Granule Loss (grams)	1.4	3.4	4.9	0.7
Tensile Strength, MD/CD (lb/in)	78/55	49/44	61/40	67/53
Compound Stability (°F)	215	215	215	215

**Adhesive strength** is the most critical performance criterion for self-adhering membranes. Greater adhesion values are critical to a leak-free roof system. Self-adhering membranes must rely on the aggressiveness of the self-adhering layer to form strong bonds, unlike hot mop and torch-down applications, which utilize molten asphalt to bond layers. The standard industry test for adhesion is called "Adhesion to Plywood," found in ASTM D1970- Self-Adhering Polymer Modified Bituminous Sheet Materials Used as Steep Roofing Underlayment for Ice Dam Protection. D1970 specifies that the minimum adhesion allowable for self-adhering underlayments is 12 lb/ft at room temperature. [See Adhesion to Plywood]

It is important to note that 12 lb/ft is the **minimum** for an **underlayment**. Products like self-adhering cap sheets need to be held to a higher standard since they are not protected by additional materials such as shingles. A performance criterion has not yet been added to D6162, D6163 and D6164 (low slope, SBS modified standard specifications), but an ASTM committee is addressing the issue.

### Adhesion to Plywood (lb/ft)

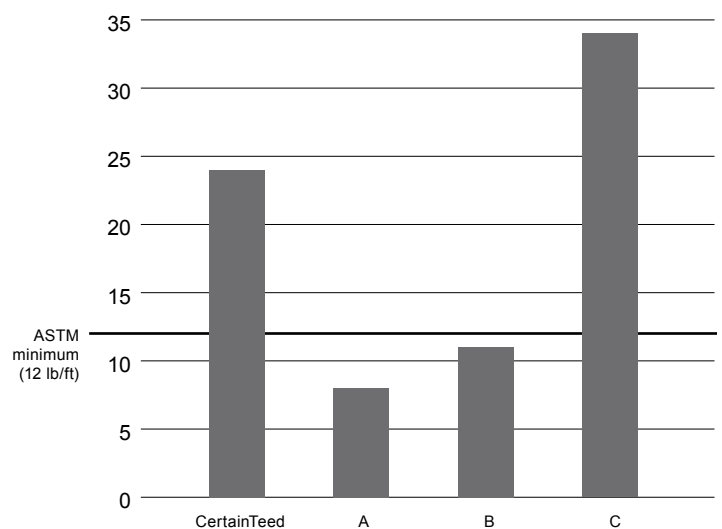



# TECHNICAL BULLETIN

## SELF-ADHERED FLINTLASTIC® SA CAP SHEET COMPETITIVE AUDIT

Only CertainTeed and one competitor are currently able to meet the criteria for underlayments. (NOTE: Adhesion criteria for cap will likely be even more stringent.)

Until a standard test and specifications are created, CertainTeed will continue testing adhesion of self-adhering cap sheets to the appropriate base sheet substrate. [See Adhesion to Base Sheet]

**Backcoating thickness** is usually associated with adhesive strength and helps provide a water-tight seal. A product may *feel* like it has a very aggressive tack, but if the amount of asphalt compound is too low the membrane will have a difficult time forming a strong bond with its substrate. A good "cushiony" layer of self-adhering compound helps to grab and hold onto uneven surfaces and surface imperfections. [See Backcoating Asphalt Content]

**Filler content** is inversely related to adhesive strength. A membrane may appear to have a thick application of self-adhering compound, but if there is too much filler added to the formulation then adhesion is lost.

Of the four products tested, three use polyester mat reinforced with fiberglass scrim or fiberglass strands while two use only fiberglass mat as a **reinforcement**. Polyester reinforced membranes are tough, puncture resistant, flexible and allow for deck movement, which is extremely important for large low-sloped roofs. Fiberglass scrim is used to add dimensional stability and strength. CertainTeed Flintlastic SA uses a polyester mat reinforced with fiberglass scrim.

The industry standard maximum **granule loss** for polymer-modified membranes is 2.0 grams. The test method can be found in ASTM D4977 - Test Method for Granule Adhesion to Mineral Surfaced Roofing by Abrasion. Granule loss below 2.0 grams is difficult to achieve on self-adhering cap sheets. The soft compound that makes the product self-adhering will also cause the product to become soft at high temperatures. This can increase granule loss and surface scuffing. CertainTeed avoids this problem by utilizing dual compound technology, with a more temperature-resistant compound under the granule surface while still maintaining an aggressive self-adhering bottom layer.

[See Granule Loss]

### Adhesion to Base Sheet (lb/ft)

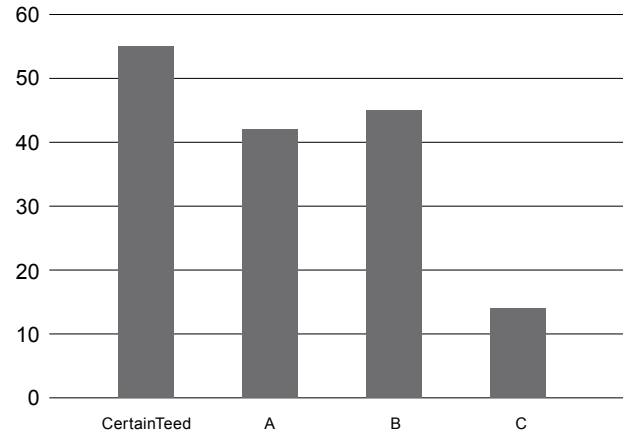

### Backcoating Asphalt Content (lb/sq)

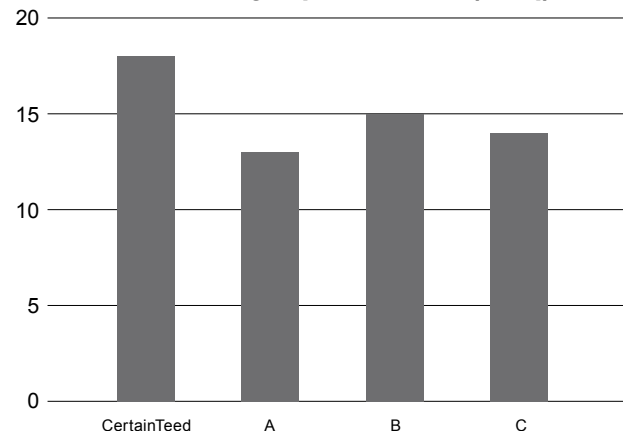

### Granule Loss (grams)

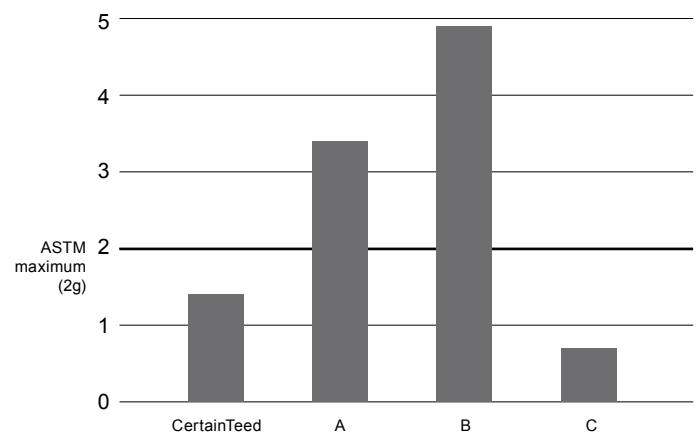

# TECHNICAL BULLETIN

## SELF-ADHERED FLINTLASTIC® SA CAP SHEET COMPETITIVE AUDIT

**Tensile strength** is an important measurement for any polymer modified bituminous sheet. It measures the ability of the membrane to resist breaking under tension and is measured in force per unit area. This test method can be found in ASTM D5147 - Standard Test Method for Sampling and Testing Modified Bituminous Sheet Material. [See Tensile Strength]

**Compound stability** is a high temperature flow test in which sections of membrane are hung vertically in a forced air oven at high temperatures. This test method can be found in ASTM D5147 - Standard Test Method for Sampling and Testing Modified Bituminous Sheet Material. Although ASTM minimum values are yet to be determined for self-adhering products, it is important to note that CertainTeed's self-adhering product line resists flow at temperatures exceeding 215°F (the passing temperature of an SBS modified product). This means that our products are well suited for both cooler temperatures (aggressive tack at room temperature) and high temperatures (compound will not flow or lose granules).

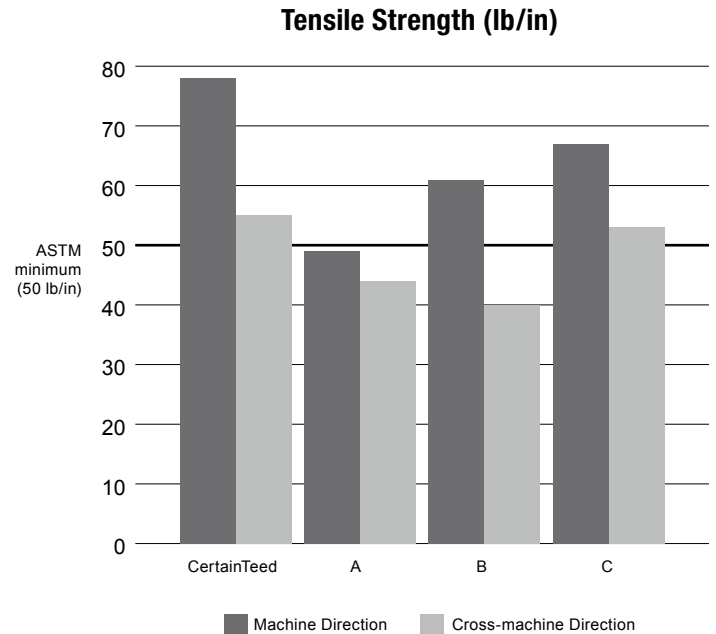

### CertainTeed

CEILINGS • DECKING • FENCE • GYPSUM • INSULATION • RAILING • ROOFING • SIDING • TRIM

20 Moores Road Malvern, PA 19355 Professional: 800-233-8990 Consumer: 800-782-8777 [certainteed.com](http://certainteed.com)

# TECHNICAL BULLETIN

## SELF-ADHERED WIND UPLIFT PERFORMANCE COMPARISON

Date: July 2019

As reported by the Asphalt Roofing Manufacturers Association (ARMA), self-adhered products are the fastest growing segment within the bituminous sector, growing an average of 9.6% year over year for the last three years. Factors driving this growth include application efficiency, applicator learning curve, elimination of flames, fumes, and the operational costs associated with torches and kettles.

Self-adhered bituminous membranes are manufactured with a bottom surface release film. The film is removed in the field, exposing factory-applied pressure sensitive adhesive which functions as the bonding agent for the roof system. Adhesive formulations are proprietary to manufacturers; bond strength and durability varies by brand. Flintlastic SA, CertainTeed's low-slope, self-adhered modified bitumen product line, has been successfully in service since 2003.

As industry acceptance and demand continues to increase, CertainTeed frequently fields requests to compare the bond and performance of our torch-applied and hot-asphalt applied roof systems to our self-adhered roof systems. Third-party quantification of a roof system's wind uplift resistance is a practical demonstration of bond strength. The wind uplift resistance of the following systems, as reported in Florida Building Code Report FL-2533-R21, illustrates equivalent or better performance across CertainTeed torch-applied and self-adhered multi-layer membranes:

Deck Type	Self-Adhered System	MDP (psf)	Torch/Hot Applied System	MDP (psf)
Wood	W-1	-45.0	W-8	-45.0
Wood	W-2	-52.5	W-9	-52.5
Wood	W-3	-52.5	W-10	-52.5
Steel	S-1	-37.5	S-8	-37.5
Steel	S-2	-45.0	S-11	-45.0
Steel	S-24	-37.5	S-31 (Hybrid)	-37.5
Concrete	C-8	-120.0	C-58 (SBS TA)	-120.0
Concrete	C-99	-630.0	C-106 (APP TA)	-630.0
Concrete	C-99	-630.0	C-107 (SBS TA)	-630.0
Concrete	C-99	-630.0	C-108 (HA Only)	-630.0
LWC	LWC-3	-150.0	LWC-9	-150.0
LWC	LWC-40	-60.0	LWC-54	-60.0
GWC	CWF-1	-45.0	CWF-4	-45.0
Gypsum	G-3	-135.0	G-10	-135.0
Recover	R-8	-157.5	R-43 (Hybrid System)	-157.5

For full report please visit CertainTeed.com: <https://www.certainteed.com/resources/FL-2533-FlintlasticModBit.pdf>

# TECHNICAL BULLETIN

## STAINING

**Date: 10/15/2019**

**Supersedes: 7/11/2013**

Staining of portions of the exposed mineral surface of modified bitumen reflective roof membranes may occur over a period of time during storage when these cap sheet membranes are stored as tightly wound rolls. Small amounts of plasticizing oils in the polymer modified bitumen could leach to the surface, or minerals used to coat the underside of the roll may transfer from the underside of the membrane to portions of the abutting exposed face of the membrane, resulting in discoloration. In some cases, staining can take the form of dark lines that correspond to the straps used to contain each roll prior to installation. Staining caused by mineral dust or oils migrating from the asphalt in the membrane is not permanent and will weather out, however the process to reach the perfect white surface may take up to three (3) months depending upon the time of year and the amount of rainfall the roof surface receives. In some geographical regions where there is little to no rainfall, the process may take longer.

Migration of oils and mineral coatings from the underside to the exposed face of the membrane is a natural process that is triggered by heat and pressure and does not constitute a manufacturing defect. CertainTeed's many years of experience in the roofing industry and our laboratory research tells us that this type of staining will be degraded by the ultraviolet rays of the sun to water soluble components and then disappear after being washed away by rainfall.

We request that customers who observe this phenomenon allow their new roofing membranes to weather for a period of 90 days; 6 months in areas where there is little rainfall. If after this time the staining persists or shows no signs of lightening, CertainTeed will remedy the condition as stipulated in our limited warranty. Fortunately, our experience has been that the vast majority of customers notice an elimination of the stain well before the 90-day period is up.



**CertainTeed**

CEILING • DECKING • FENCE • GYPSUM • INSULATION • RAILING • ROOFING • SIDING • TRIM

20 Moores Road Malvern, PA 19355 Professional: 800-233-8990 Consumer: 800-782-8777 [certainteed.com](http://certainteed.com)

© 01/20 CertainTeed, Printed in the USA

# TECHNICAL BULLETIN

## WOODBLOCKING

FM Global Property Loss Prevention Data Sheet 1-49 (LPDS 1-49) states:

*“The majority of roof covering failures resulting from windstorms involve improperly designed or constructed perimeter flashings.”<sup>1</sup>*

The perimeter of the roof assembly sustains the highest wind loads during wind events. The proper application of woodblocking will serve to strengthen the roof system by providing a strong attachment base for the connection of the roof assembly and metal flashings.

Both adhered and systems bonded to mechanically attached base sheets have the advantage of physical bonding or attachment to the deck. However, all of these roof assemblies depend on the strength and attachment of the woodblocking to resist wind loads placed on flashings and perimeter membranes. The loss of attachment from the woodblocking can potentially mean the loss of the roof system, at least at perimeters and corners.

In general, there are three types of loads that perimeter woodblocking anchors must withstand when securing a roof system and perimeter flashings (see Figure 1):

- Tensile Load: applied parallel to the axis of the anchor;
- Shear Load: applied perpendicular to the axis of the anchor; and
- Oblique Load: Also known as a combination load, it applies stress with the qualities of both a tensile and a shear load.

Load conditions at the perimeter vary depending on wind speed, perimeter conditions, and substrate material.

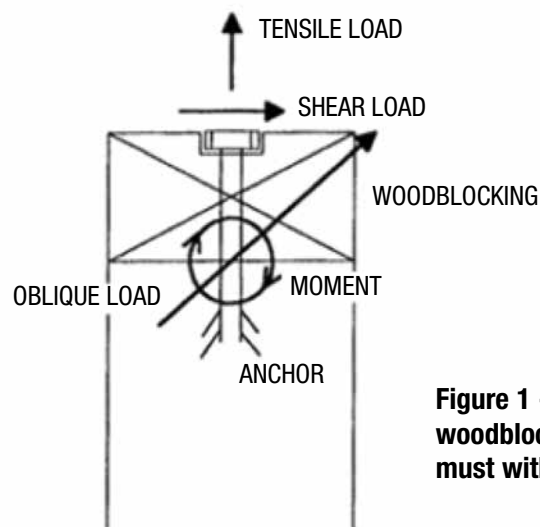

**Figure 1 - Loads which woodblocking anchors must withstand**

<sup>1</sup> Factory Mutual Global Loss Prevention Data Sheet 1-49: Perimeter Flashings.

# TECHNICAL BULLETIN

## WOODBLOCKING

Following recommended guidelines for woodblocking attachment is critical in preventing catastrophic damage caused by poorly maintained or improperly installed roof components. If installed correctly, perimeter woodblocking can play a crucial role in strengthening and protecting a building's roof system, no matter what design or material is being utilized.

### RECOMMENDATIONS FOR SECURING PERIMETER WOODBLOCKING

Both FM Global Loss Prevention Data Sheet 1-49 and industry standards provide recommendations and guidelines on woodblocking construction and attachment. FM Global (FMG) publishes recommendations only for concrete, masonry and steel decks in the Loss Prevention Data Sheets.

While industry standard guidelines do address a variety of attachment methods and formulas, they do not address safety factors related to specific deck types. Instead, they provide general recommendations for spacing and attachment. The phrase most commonly found in guideline specifications is "attachment of woodblocking to resist a minimum pull-out resistance of 175 lbf/ft in all directions." In some specifications, this recommendation has been increased to 350 lbf/ft in all directions.

While these guidelines might provide a useful starting formula for attaching woodblocking, the following recommendations addressing specific deck types, and based on laboratory and field testing, provide detailed guidelines for woodblocking attachment.

### CONCRETE

For concrete and masonry, FMG recommends a minimum ½" diameter corrosion resistant anchor, combined with a minimum 1" diameter bearing washer embedded into the woodblocking. It is further recommended that the anchor and washer be recessed into woodblocking at least 1½" thick, spaced at a maximum of 48" o.c. (24" at corners). Note withdrawal resistance testing should be carried out in compliance with ANSI/SPRI FX-1-2006<sup>2</sup> or Metro Dade TAS 105<sup>3</sup>.

For buildings with concrete decks, the fastener design load should not be less than 250 lbf/ft after application of a 4:1 safety factor. The pull-over value should not be less than 125% of the design load and, if necessary, a larger bearing washer should be utilized to achieve this requirement. A variety of different fasteners and anchors can be utilized to achieve these recommendations, though certain conditions, such as concrete substrates with a compressive strength of less than 2,500 psi or thickness less than 2½", will require on-site performance testing to ensure design criteria are being met.

---

<sup>2</sup> ANSI/SPRI FX-1-2006: Standard Field Test Procedure for Determining the Withdrawal Resistance of Roofing Fasteners.

<sup>3</sup> TAS 105: Test Procedure for Field Withdrawal Resistance Testing.

# TECHNICAL BULLETIN

## WOODBLOCKING

**Table 1 - Anchor type, size and spacing criteria for concrete decks**

ANCHOR TYPE	DIAMETER	SPACING
Wedge Anchor	½"	40" o.c.
Sleeve Anchor	⅜"	30" o.c.
Threaded Concrete Anchor	¼"	12" o.c.
Drive Anchor	¼"	12" o.c.
Spike Anchor	¼"	12" o.c.

### STEEL

For steel decks, FM Global recommends ¾" diameter bolts drilled and tapped into a structural steel member or bar joists spaced between 48" and 72" o.c. depending on perimeter conditions.

Woodblocking attached to 18 to 22 ga. steel roof deck can be carried out using #14 or #15 diameter threaded fasteners. These fasteners have an average withdrawal 460 lbf from 33 KSI, 22 gauge steel decking. The industry accepted margin of safety is 1.5:1 with a pull-over value of not less than 125%.

Where woodblocking is attached perpendicular to the deck flute, it is recommended that fasteners be positioned over the high flanges of the deck, 12" o.c. (6" in corners). Where woodblocking runs parallel to the flutes, similar spacing is recommended, with the addition of ¼" diameter self-tapping screws through the woodblocking deck and bar joist, spaced not greater than 6'. A #14 type 'B' fastener can be installed into a pre-drilled hole using a #1 twist drill. The possibility exists that the steel deck is poorly attached to structural components, especially on re-roofing projects. The decking can be mechanically attached to the bar joists with either a self-tapping fastener or a #4 or #5 pt. self-driller with a minimum 7/8" bearing washer.

For those metal decks using light-gauge metal (less than 22 ga.), the following formula can be utilized to determine fastener spacing:  $X_{mn} \times FS = X_{fst} \div MS$  ( $X_{mn}$  = Minimum withdrawal resistance = Known (1);  $FS$  = Fastener spacing = Unknown;  $X_{fst}$  = Average fastener withdrawal = Known;  $MS$  = Margin of safety = 2). As with standard metal decks, woodblocking attached parallel to the ribs should be secured to steel angles, or mechanically secured to bar joists using self-trapping or self-drilling fasteners.

### "LIGHTWEIGHT" DECKS (GYPSUM, TECTUM, LIGHTWEIGHT INSULATING AND CELLULAR CONCRETE)

Due to the low density of these deck materials and the load combinations they sustain, attaching woodblocking to lightweight decks is not recommended. In general, the deck should not be used as an attachment substrate unless the chosen anchor can clamp to the underside of the deck or attach to a structural member below, and achieve not less than 425 lbf ultimate load.

In order to determine fastener spacing, the following formula with a 4:1 margin of safety

# TECHNICAL BULLETIN

## WOODBLOCKING

should be used:  $X_{mn} \times FS = X_{fst} \div MS$  ( $X_{mn}$  = Design withdrawal resistance = 250 lbf/lineal foot;  $FS$  = Fastener spacing = Unknown;  $X_{fst}$  = Average fastener withdrawal resistance = Known;  $MS$  = Margin of safety = 4). Toggle bolts are not recommended for fastening as they require a large hole for installation and rely on a trunnion nut to hold the toggle rod to the wing.

### VERTICAL WALLS

Woodblocking can also be attached to vertical walls (See Figure 2). In these cases, the woodblocking should have a minimum thickness of 1½" with fasteners spaced not greater than 12" apart. Each anchor should have a minimum withdrawal resistance value of 800 lbf. Larger diameter threaded concrete anchors or hammer-in anchors are preferred in order to draw the blocking tight to the substrate.

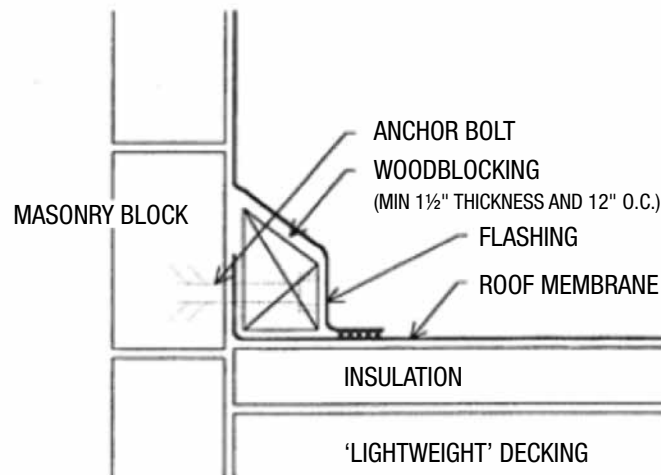

**Figure 2 - Woodblocking attachment to vertical wall**



# TECHNICAL BULLETIN

## SPECIFYING ROOFING SYSTEM WIND UPLIFT RESISTANCE

For many years the United States had numerous model building codes, all of which had differing criteria for the calculation of wind loads for low-slope roofing. The lack of continuity created confusion driving specifiers to rely on the insurance industry, and in particular, Factory Mutual Research Corp. (FMRC), the primary entity in the United States testing and approving roof assemblies with ratings related to wind uplift, fire and hail resistivity. FMRC became the default specification for wind uplift criteria whether the building was insured by FMRC or not. The objective of this document is to provide perspective around specifying wind uplift requirements.

In 1994, the South Florida Building Code published a new revision of the building code following Hurricane Andrew that required roof assemblies to meet the uplift resistance requirements as calculated using ASCE-7, the new wind load standard published by The American Society of Civil Engineers and the successor of ANSI A58.1. The South Florida Building Code began approving laboratories to run uplift resistance testing using the FMRC test criteria, Test Standards 4450 and 4470, as the test protocol. All projects submitted for permit had to include wind load calculations and evidence of successful testing at an approved laboratory. Over time, these tests were incorporated into a “Notice of Acceptance” that listed the testing at approved laboratories and the published testing from both FMRC and Underwriter’s Laboratories.

For the rest of the country, the practice of specifying a FMRC rating, such as FM Class 1-60 or FM Class 1-90, was commonplace, providing a specifier with some level of assurance that the system had been tested for wind uplift resistance. In essence, FMRC became the de facto national standard for wind uplift requirements.

During the development of the International Building Code (IBC), this issue was addressed and clarified by adopting ASCE-7 as the wind load standard for roofing. Laboratories certified by the International Code Council (ICC) – the successor to BOCA, UBC and SBC – began testing roofing assemblies for uplift resistance for publication in ICC Evaluation Reports and for evaluation by local building officials. Of course, testing at FMRC (now FM Global) and at Underwriter’s Laboratories could also be submitted for evaluation. With the 50 states adopting the majority of the IBC there was finally a standard for wind uplift testing and evaluation throughout the United States. While the South Florida Code differs, the calculation of wind loads is the same as the rest of the country. ASCE-7 is updated regularly, and at times may not be synchronized with the building code. For example, some jurisdictions may be enforcing the 2009 revision of the IBC when there is a 2010 version of ASCE-7. The code in force at the time of permitting will clearly state the version of ASCE-7 that is currently in force for that particular jurisdiction.

For non-FM Global insured projects, compliance with the building code simply requires a roof design for wind loading to be in compliance with the version of ASCE-7 in force at the time of permitting, and test data to confirm the submitted system is in compliance. Note that this will not only require compliance in the field but enhanced criteria for perimeters and corners. The test data to support compliance may be in a current Evaluation Report, or may be a recent test by a certified laboratory that demonstrates performance. There are some jurisdictions that do not require building permits for re-roofing; however, the installer is still obligated to install a roof assembly that meets code, including the wind uplift resistance requirements for the specific building. The design professional responsible for the project typically completes wind load calculations. The requirements in each jurisdiction may vary; therefore it is best to consult your local building official for specific requirements. For the current code requirements, please review Section 1504.3 of the 2012 IBC.

If FM Global insures the structure, or the specifier has used FM Global as the sole criteria for calculating wind loads, there is an additional step needed to comply with project documents. As a baseline, all projects must meet the ICC requirements noted above; in addition, the project must meet the design criteria for the structure outlined in the FM Global *Loss Prevention Data Sheet 1-28*. This document provides the necessary data, when read in conjunction with

# TECHNICAL BULLETIN

## SPECIFYING ROOFING SYSTEM WIND UPLIFT RESISTANCE

the FM Global *Loss Prevention Data Sheet 1-29*, to calculate wind- uplift resistance for any project insured by, or specified under FM Global criteria. In many cases, the specifier will include in the specification the field, perimeter and corner pressures eliminating the need to complete the calculations. If the project is FM Global insured, the calculations and proposed roof system are submitted to the FM Global Design Review Desk for evaluation. The reviewer will provide any revisions or modifications in writing. It is helpful to include with the project submission the *account* and *index* numbers to insure proper building identification.

If the structure is not insured by FM Global, but has been used as the basis of design, it is the designer of record who will review the submission and compare it to systems *approved* or *accepted* by FM Global. Approved systems can be found in FM Global *RoofNav*, an on-line database of approved systems that can be accessed by the public after a registration process. RoofNav lists all systems currently approved by FM Global and published in their current *FM Global Directory*. It is important to note that FM Global lists approvals using ratings of 1-60, 1-75, 1-90, etc. The “1” is a designation for a Class 1 assembly as designated in Test Standards 4450 and 4470. This “Class” addresses both the roof assembly and the roof deck. The numeric designation (60, 75, 90, etc.) is the calculated wind uplift pressures with a 2:1 margin of safety applied. Therefore, a system listed as a “60” system can be utilized for projects where the roof field pressures are calculated to be 30 psf or less. The margin of safety is the criteria established in the test protocol, which acknowledges the differences between the laboratory and field environments.

FM Global can also assist, responding to both email and telephone inquiries. It is important to bear in mind that these services are typically provided for any project insured by FM Global.

Notwithstanding a specification requirement to comply with FM Global, the building code requirements within the jurisdiction must be met. CertainTeed has hundreds of roof assemblies tested and listed by certified testing laboratories FM Global and Underwriter’s Laboratories. CertainTeed Tech Services can assist in identifying roof assemblies that meet specific project requirements whether *built-up*, *modified bitumen*, *self-adhered* or a *hybrid system*.

CertainTeed Commercial Roofing has designed and tested systems for over 50 years, amassing approvals and listings for hundreds of systems utilizing both CertainTeed and CertainTeed-accepted accessories. Our Technical Service representatives can assist in identifying the right systems for every project need.



**CertainTeed**

CEILINGS • DECKING • FENCE • GYPSUM • INSULATION • RAILING • ROOFING • SIDING • TRIM

20 Moores Road Malvern, PA 19355 Professional: 800-233-8990 Consumer: 800-782-8777 [certainteed.com](http://certainteed.com)