

Ecophon® Solo™ Baffle

Hook Installation Manual

DESIGN AND SPECIFICATIONS

Use of the Product

Ecophon Solo Baffles are high performing ceiling sound absorbers, capable of being used in applications as the primary acoustic solution when a traditional acoustic ceiling is neither feasible nor aesthetically desirable. Ecophon Solo Baffles are unique, free-hanging units offering numerous design possibilities which can be achieved through various color and suspension options.

Surfaces

Ecophon® Solo panels are manufactured from high-recycled fiberglass content (70% post-consumer). The front and back surfaces consist of the Akutex™ FT finish, which is highly light reflectant (85%), and has exceptional light diffusion (+99%). The sides of the panels are fully painted.

Accessibility

The panels can be easily demounted.

Edge Detail

The panels have square edges that are fully painted. Baffle edges can be modified in the field. It is recommend to seal cut edges with Ecophon edge sealant. If cutting between the anchors, remove anchor from cut edge and re-insert anchor into baffle matching the position of remaining anchor.

Attachment

There are two methods for attachment for the Hook installation. The first is the use of adjustable wire hangers, for variable elevations. The second is the use of baffle clips and a suspended grid system, for singular elevations and ease of aligning panels.

Cleaning

Daily dusting and vacuum cleaning. Weekly wet wiping.



Fire Performance

Ecophon Solo Baffle panels have been tested according to ASTM E84 and ASTM E1264 (Flame Spread ≤ 25; Smoke Development ≤ 50).

Influence of Climate

Install in conditions that do not exceed 95% relative humidity and 86-degrees Fahrenheit.

Product Attributes

Rectangle	SKU	Dimensions mm (=in.)	Lbs./carton
	3544 2619	200 x 1200 x 40 (=8 x 48 x 1-1/2)	23
	3544 2090	300 x 1200 x 40 (=12 x 48 x 1-1/2)	35
	3544 2632	600 x 1200 x 40 (=24 x 48 x 1-1/2)	34
	3544 7852	200 x 1800 x 40 (=8 x 72 x 1-1/2)	36
	3544 7851	300 x 1800 x 40 (=12 x 72 x 1-1/2)	50
	3544 7850	600 x 1800 x 40 (=24 x 72 x 1-1/2)	50
Wave	SKU	Dimensions mm (=in.)	Lbs./carton
	3544 8105	300 x 1800 x 40 (=12 x 72 x 1-1/2)	50
	3544 8104	600 x 1800 x 40 (=24 x 72 x 1-1/2)	50
Zig Zag	SKU	Dimensions mm (=in.)	Lbs./carton
	3544 8005	300 x 1800 x 40 (=12 x 72 x 1-1/2)	30
	3544 8004	600 x 1800 x 40 (=24 x 72 x 1-1/2)	51

Installation for Ecophon® Solo™ Baffle Hook

Read the entire manual before installing.

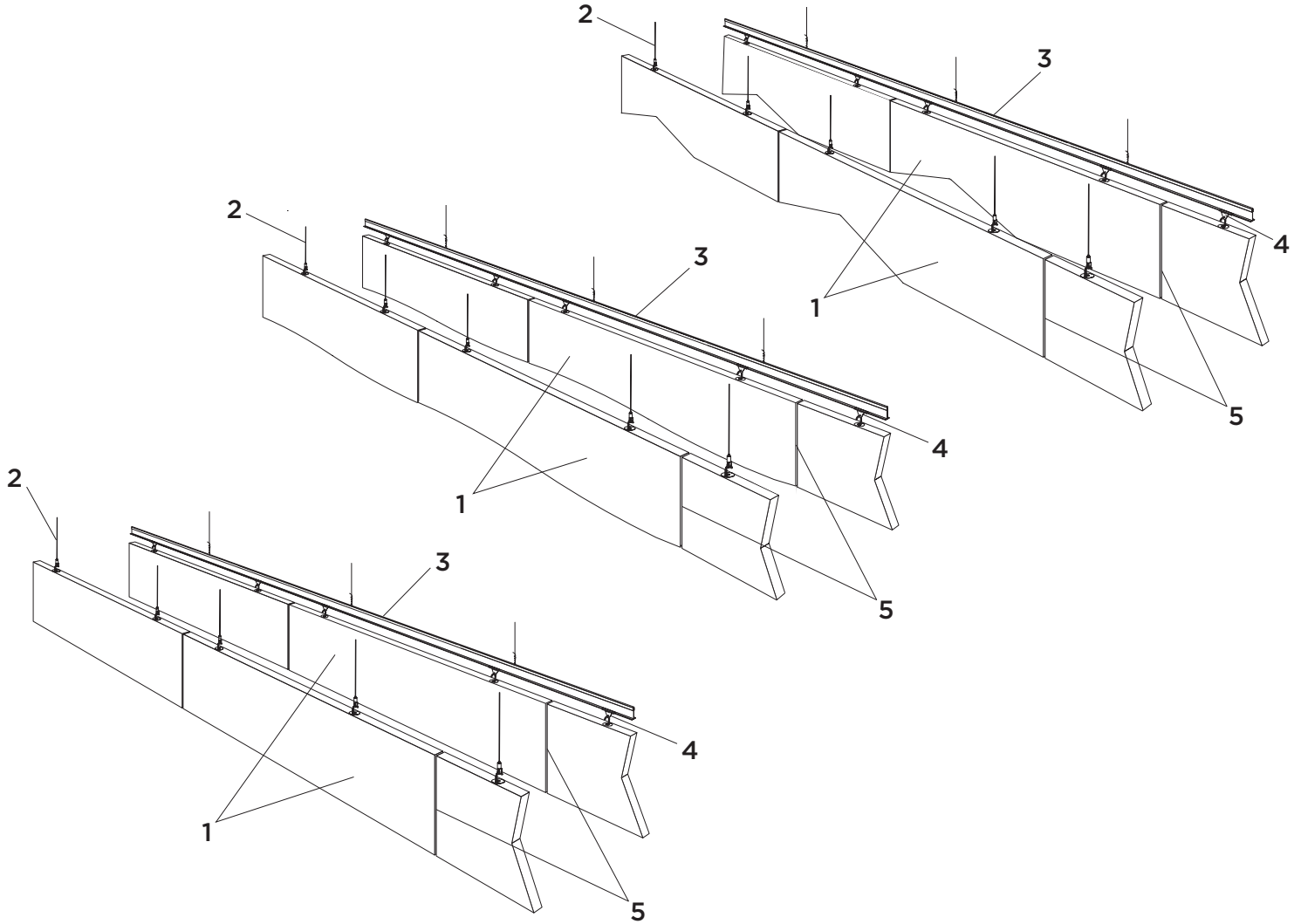

1. Ecophon Solo Baffle Hook

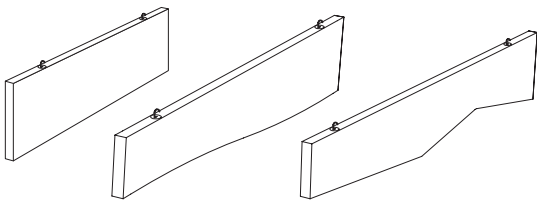

Attachment Method #1

2. Connect Adjustable Wire Hanger
2647 2174 - 2000mm (≈6'-6")
2647 2180 - 5000mm (≈16'-4")

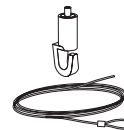

Attachment Method #2

3. CertainTeed 15/16" Classic Stab System
(system components determined
by Baffle layout)

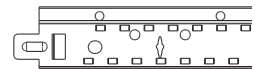

4. Connect Baffle Clip
(2-piece)
2630 1201



5. Connect Guiding Pin
2631 1768
(optional, use as required)



Installation for Ecophon® Solo™ Baffle Hook —

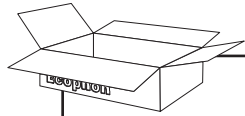

600mm x 1200mm
(≈24" x 48")

x5

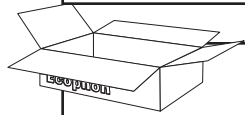
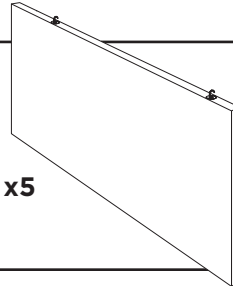

300mm x 1200mm
(≈12" x 48")

x10

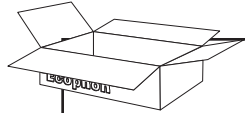
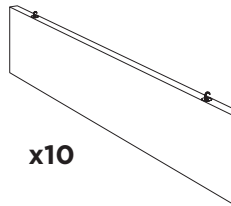

200mm x 1200mm
(≈8" x 48")

x10

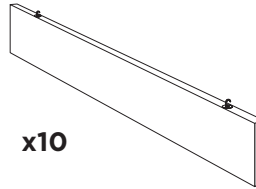

600mm x 1800mm
(≈24" x 72")

x4

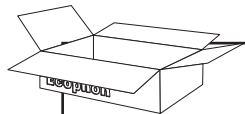
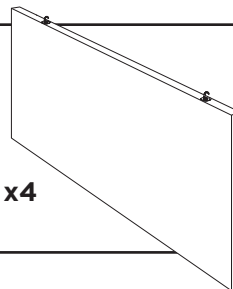

300mm x 1800mm
(≈12" x 72")

x8

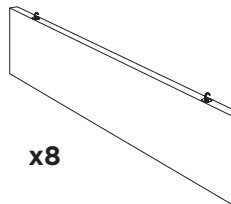

200mm x 1800mm
(≈8" x 72")

x8

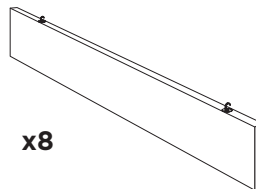

Installation for Ecophon® Solo™ Baffle Wave Hook — Connect Adjustable Wire Hanger Application

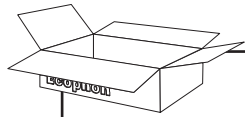

300/600 x 1800
(≈12/24" x 72")

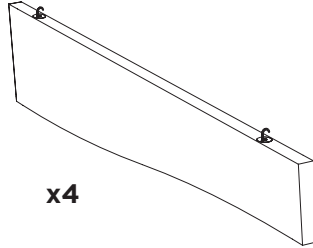

x4



200/300 x 1800
(≈8/12" x 72")

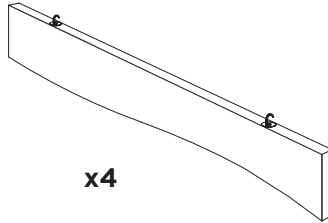

x4

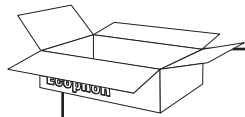

300/600 x 1800
(≈12/24" x 72")

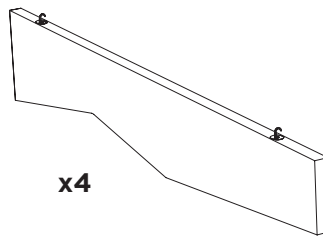

x4

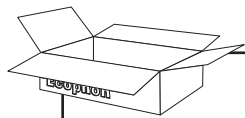

200/300 x 1800
(≈8/12" x 72")

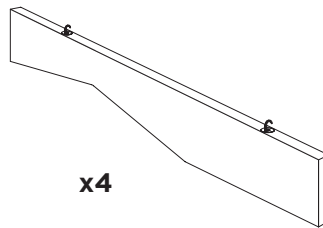

x4

Installation for Ecophon® Solo™ Baffle Hook — Attachment Method #1: Use of Adjustable Hanger Wire

Install instructions apply to all shapes and lengths.

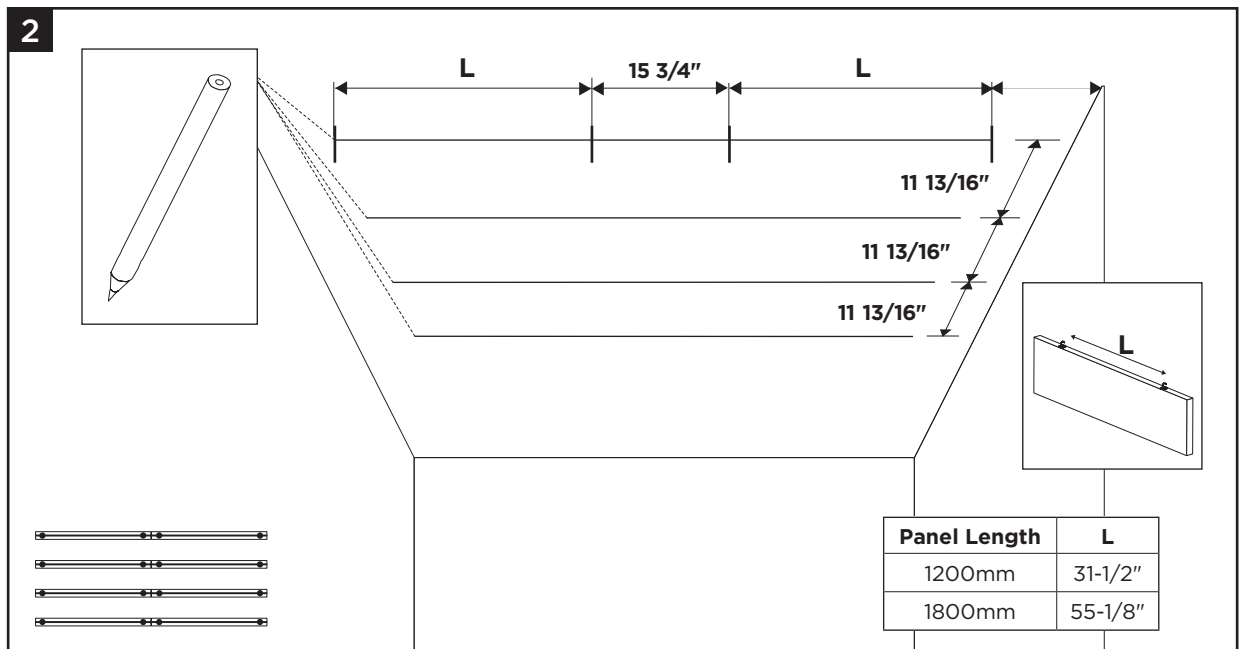
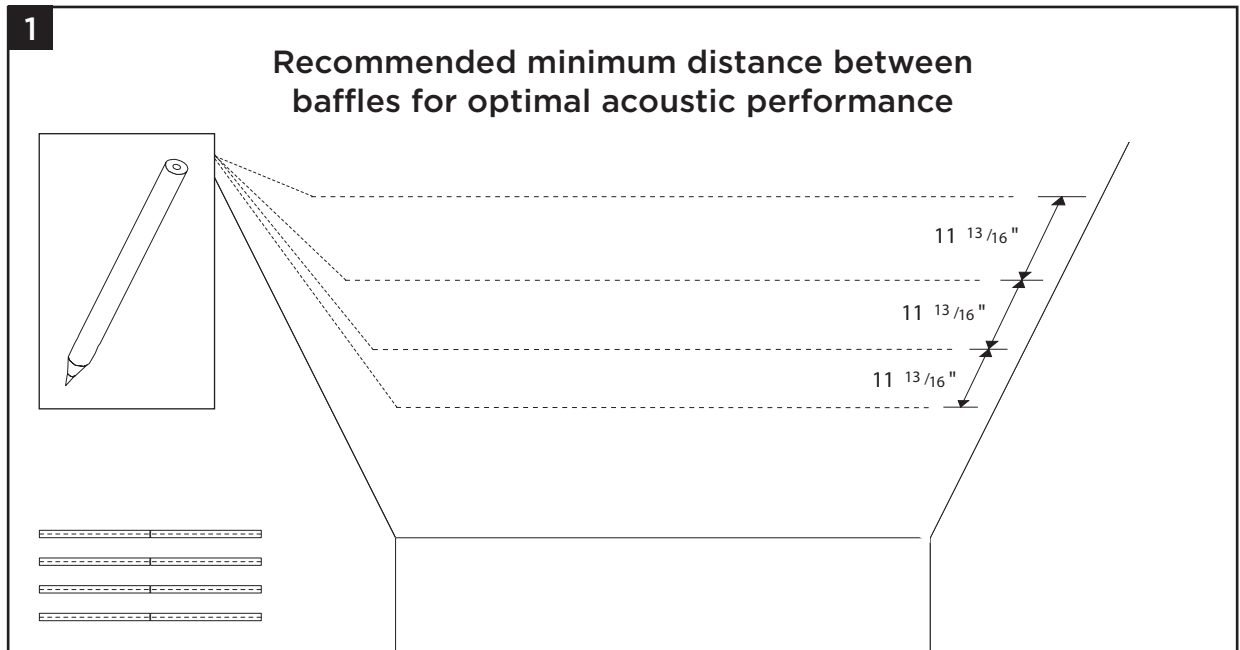

Installation for Ecophon® Solo™ Baffle Hook —
Attachment Method #1: Use of Adjustable Hanger Wire

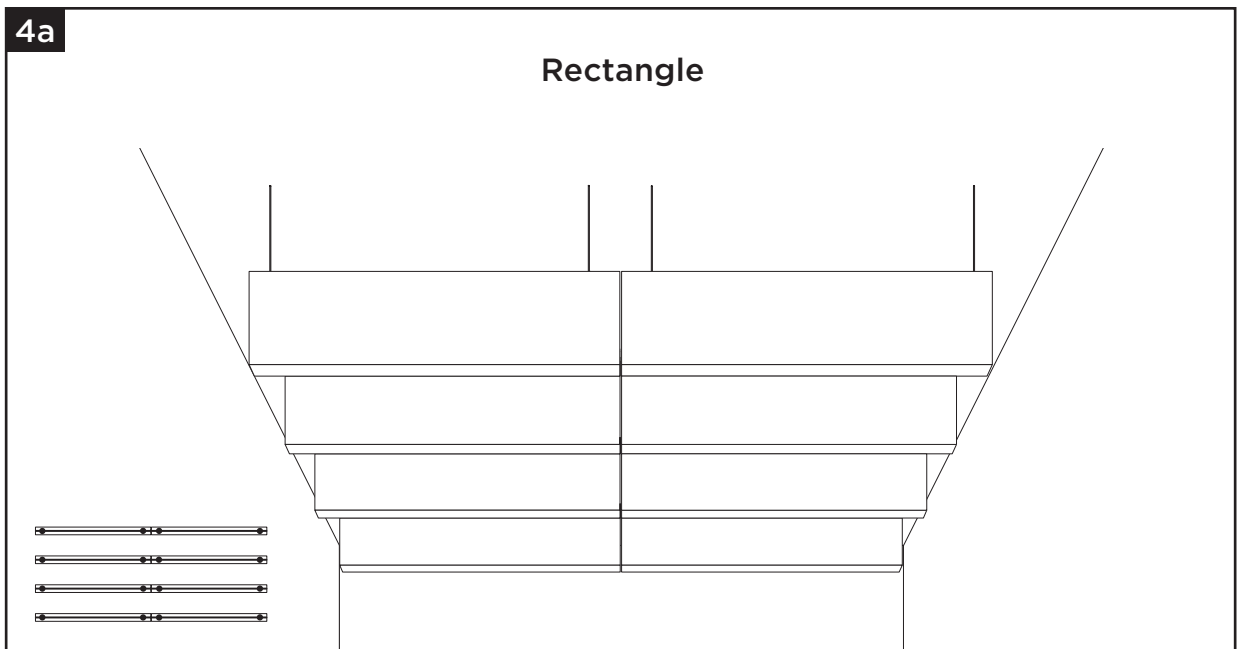
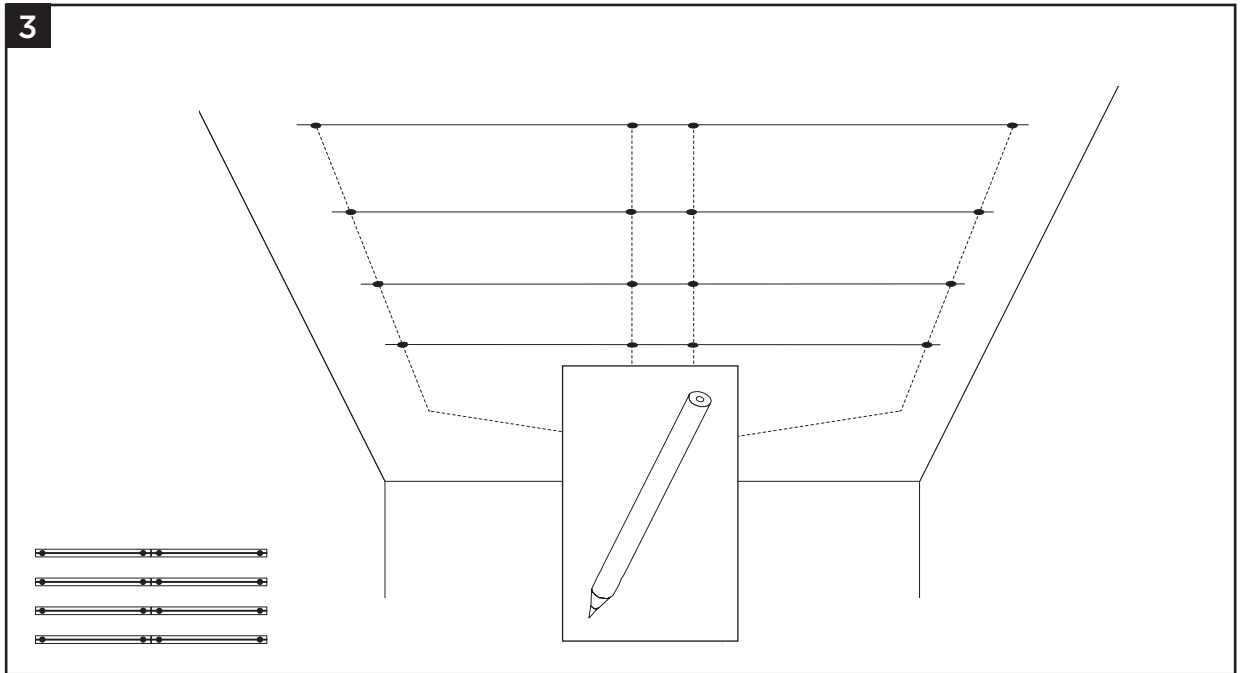

Installation for Ecophon® Solo™ Baffle Hook — Attachment Method #1: Use of Adjustable Hanger Wire

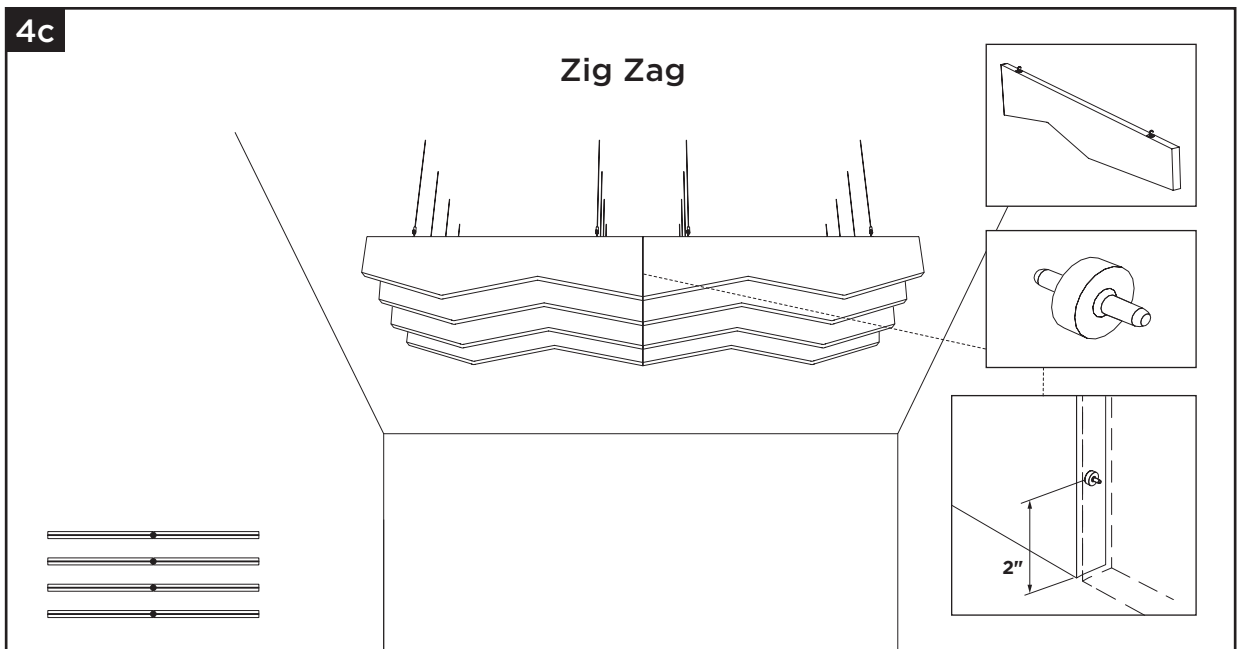
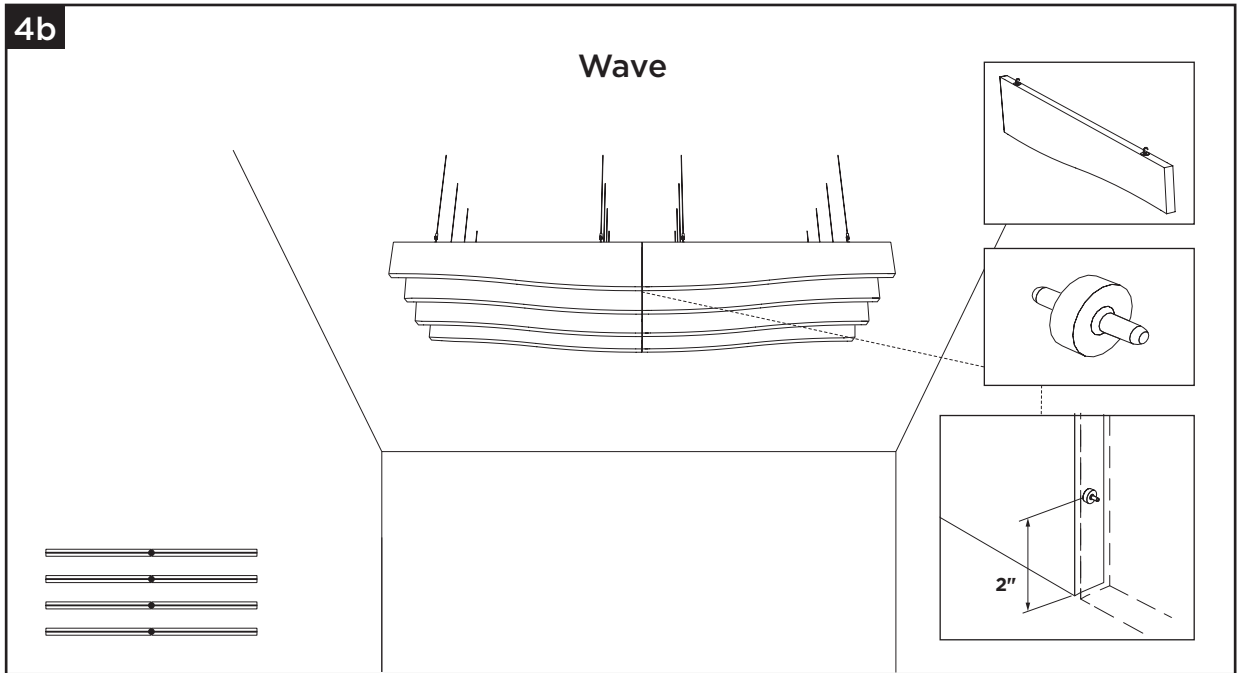

Installation for Ecophon® Solo™ Baffle Wave Hook — Attachment Method #2: Use of Baffle Clips and a Suspended Grid System

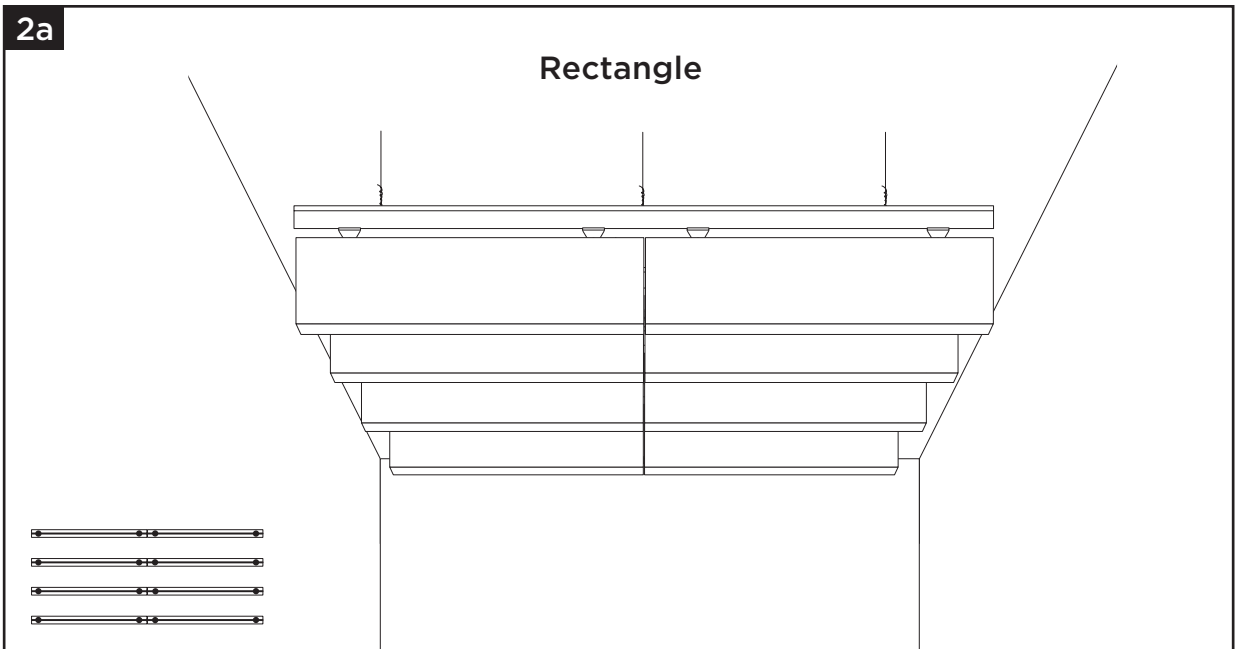
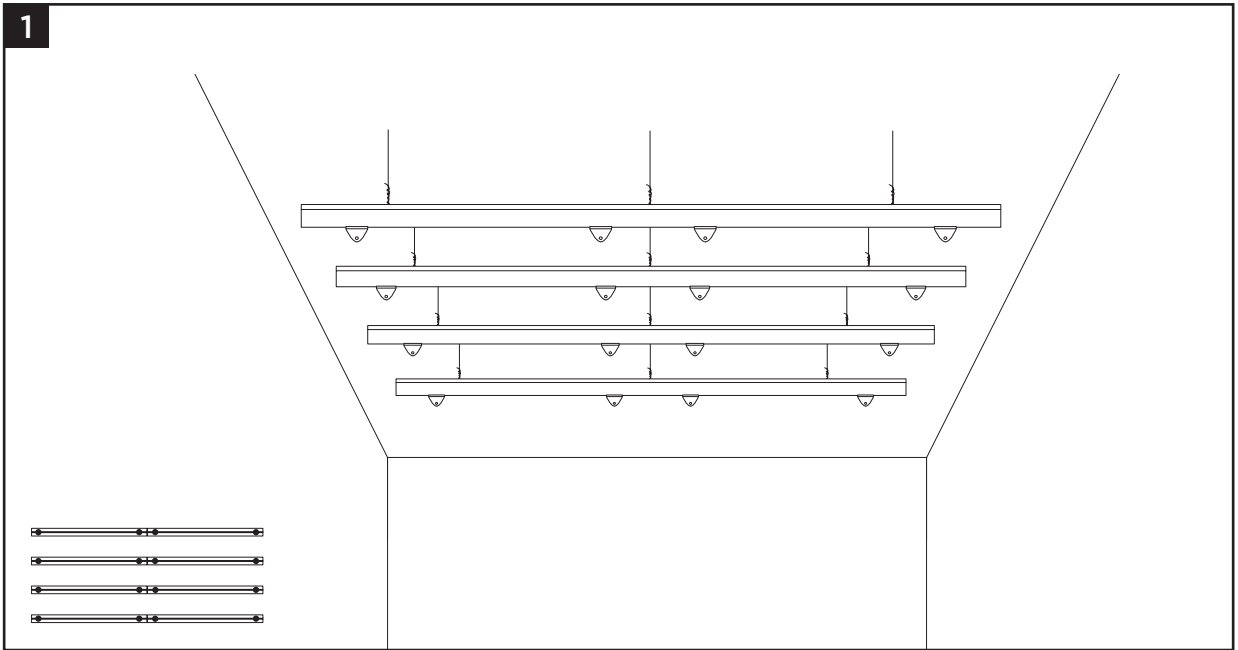

Installation for Ecophon® Solo™ Baffle Wave Hook — Attachment Method #2: Use of Baffle Clips and a Suspended Grid System

