

ECOPHON® Focus™ Ds 2x2 – 2x8

Installation Manual

Read the entire manual before installing.

Suited only for seismic categories A, B. (refer to "alternative installation" for categories C, D, E, F)

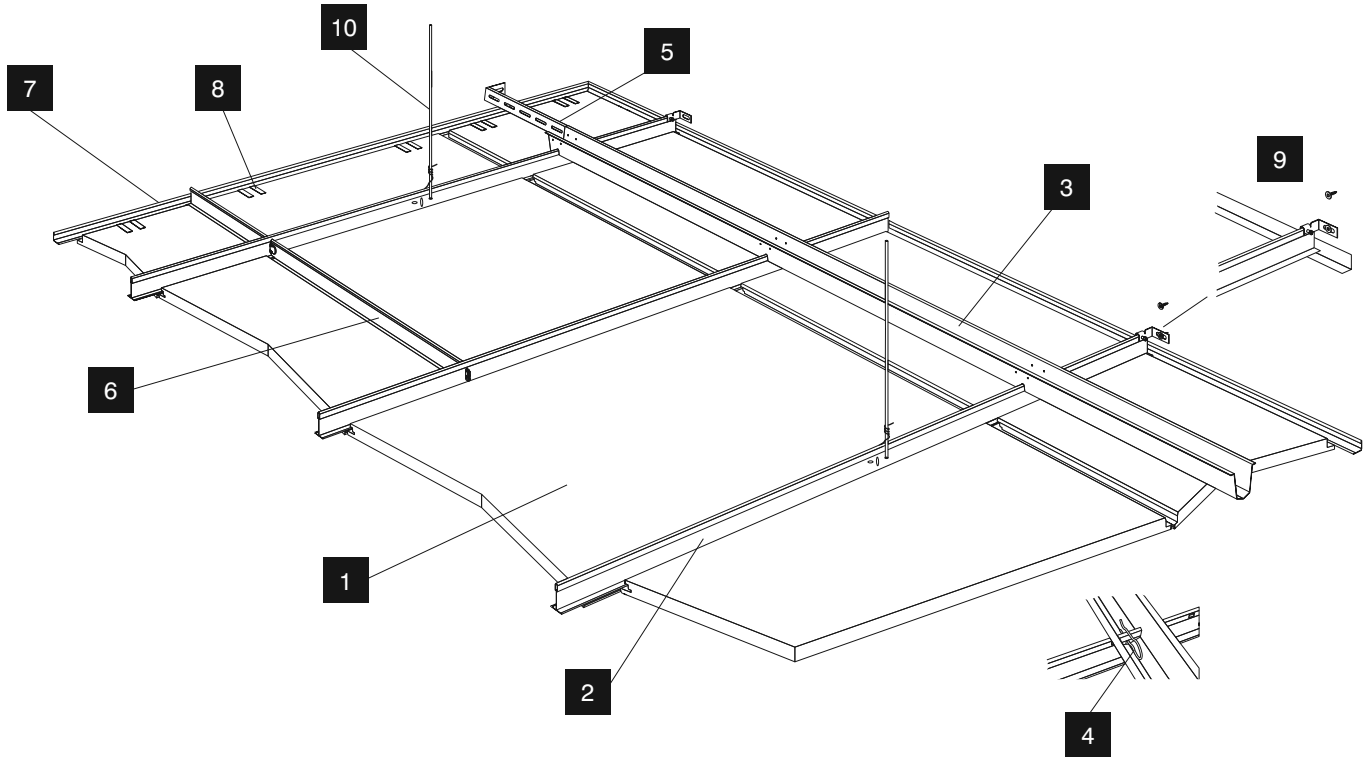

1 Ecophon Focus Ds Panel (2'x2' - 2'x8')

2 CTC 15/16" Classic Stab HD Main Runners CS12-12-20

3 Connect Space Bar 0577 (fits only CTC HD main runners) Slotted 6" O.C.

4 Connect Space Bar Winch 2630 0553

5 Ecophon Connect Wall Bracket Space Bar 0525 (All required screws by others)

6 15/16" Cross Tee (Where needed, must be compatible with main runner)

7 CertainTeed Ceilings 15/16" Wall Angle

8 Connect DG20 Support Clip 0547

9 Connect Wall Bracket T-profile 0524 (All required screws by others)

10 12 Gauge Hanger Wire

11 Connect Perimeter Tile Clip 2631 1080

Additional Components:

12 Connect DG Cutting Tool 0991

13 Connect Edge Sealant 0691

Installation for Ecophon® Focus™ Ds for 2x2, 2x4, 2x5, 2x6, & 2x8 Panels

Install in conditions that do not exceed 70% relative humidity and 77-degrees F

Pre-Installation: Please read CertainTeed Ceiling's Pre-Installation Instructions before you begin this installation and wear clean white gloves when installing the product. Note that the finished surface of Focus Ds Panels is 1/2" below the grid. **Focus Ds is an extremely precise system and the tolerance is near zero. The grid system must be square and level.**

1. Installing Wall Angle

- a. To install Wall Angle choose a height at least 5½" below joists, existing ceilings, ducts, pipes, or wiring, to ensure clearance and maneuverability required to install the panels (integration with diffusers and light fixtures may dictate a greater depth of system).
- b. Mark the desired height for the finished surface of the ceiling on all four walls (see Steps 2-3).
- c. Attach Wall Angle using appropriate fasteners.

Perimeter Detail

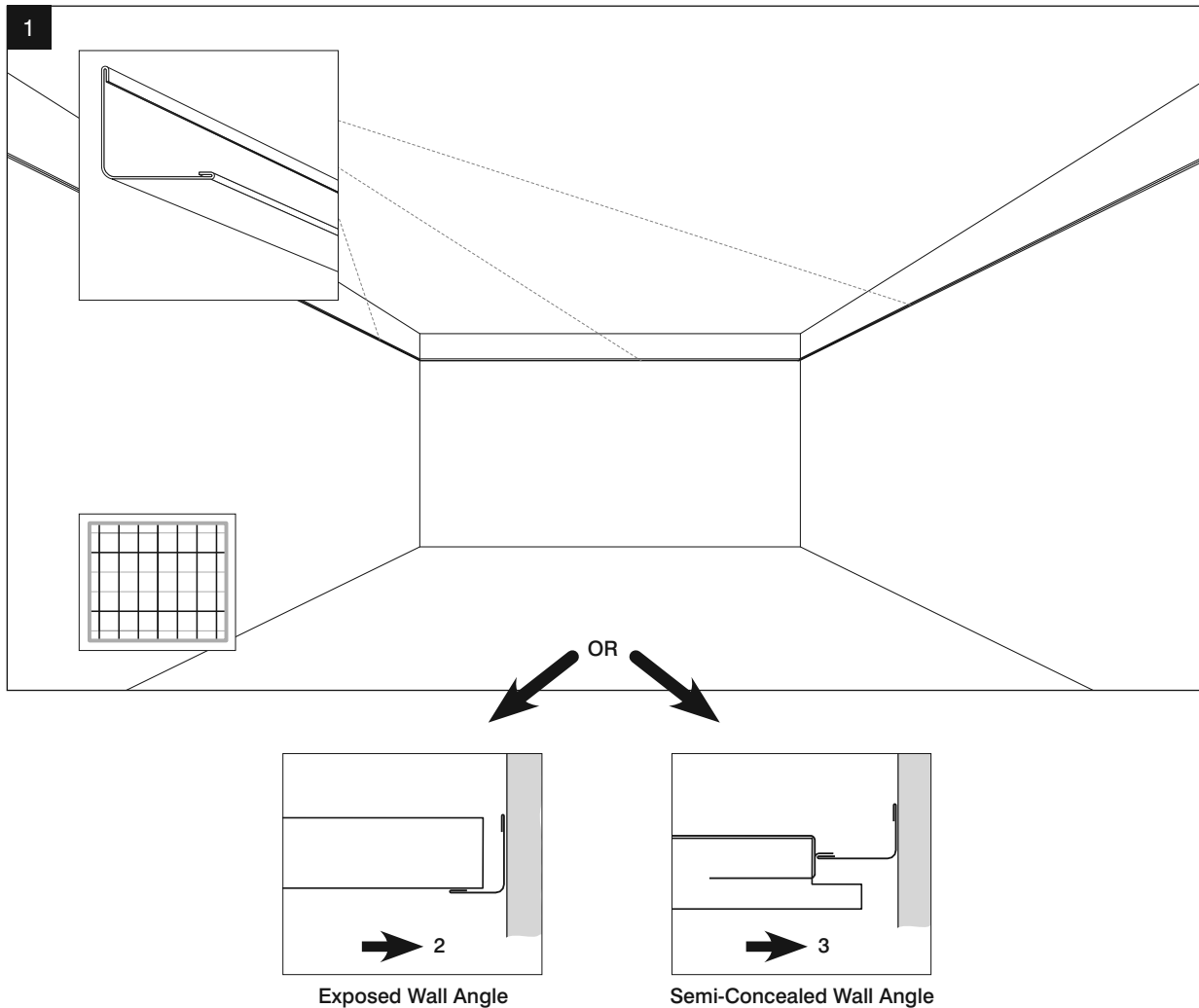

Installation for Ecophon® Focus™ Ds for 2x2, 2x4, 2x5, 2x6, & 2x8 Panels

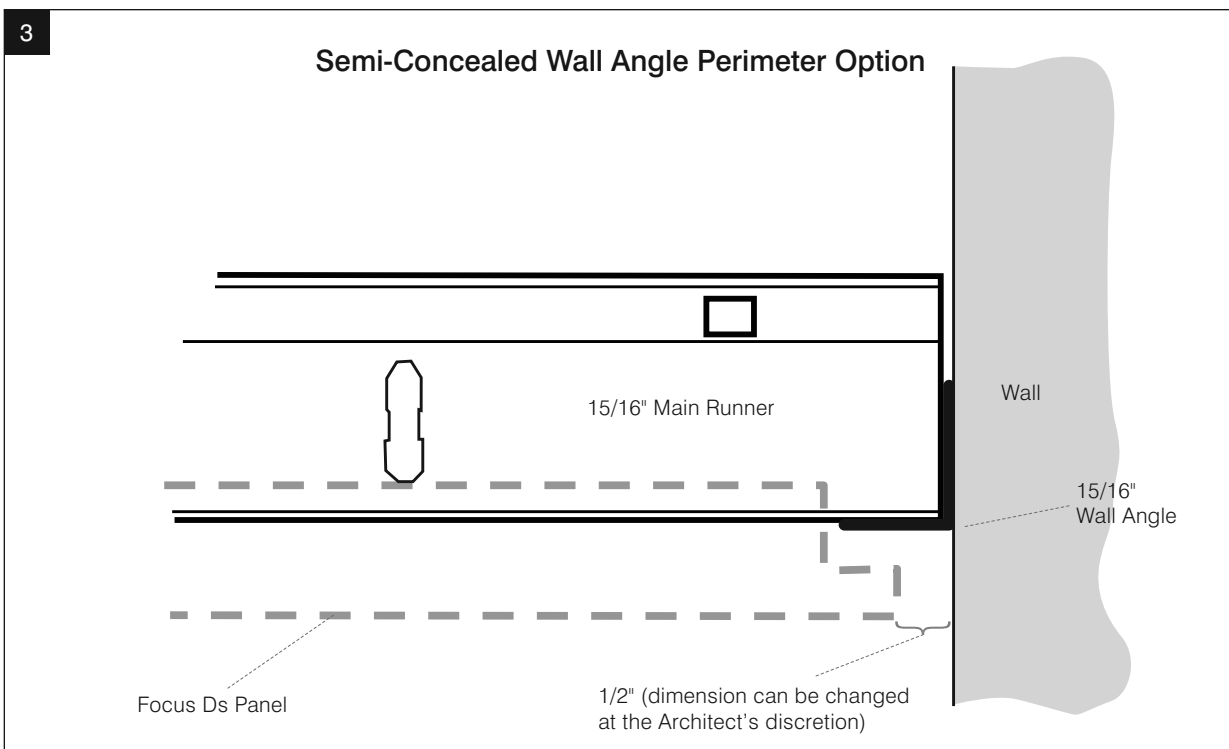
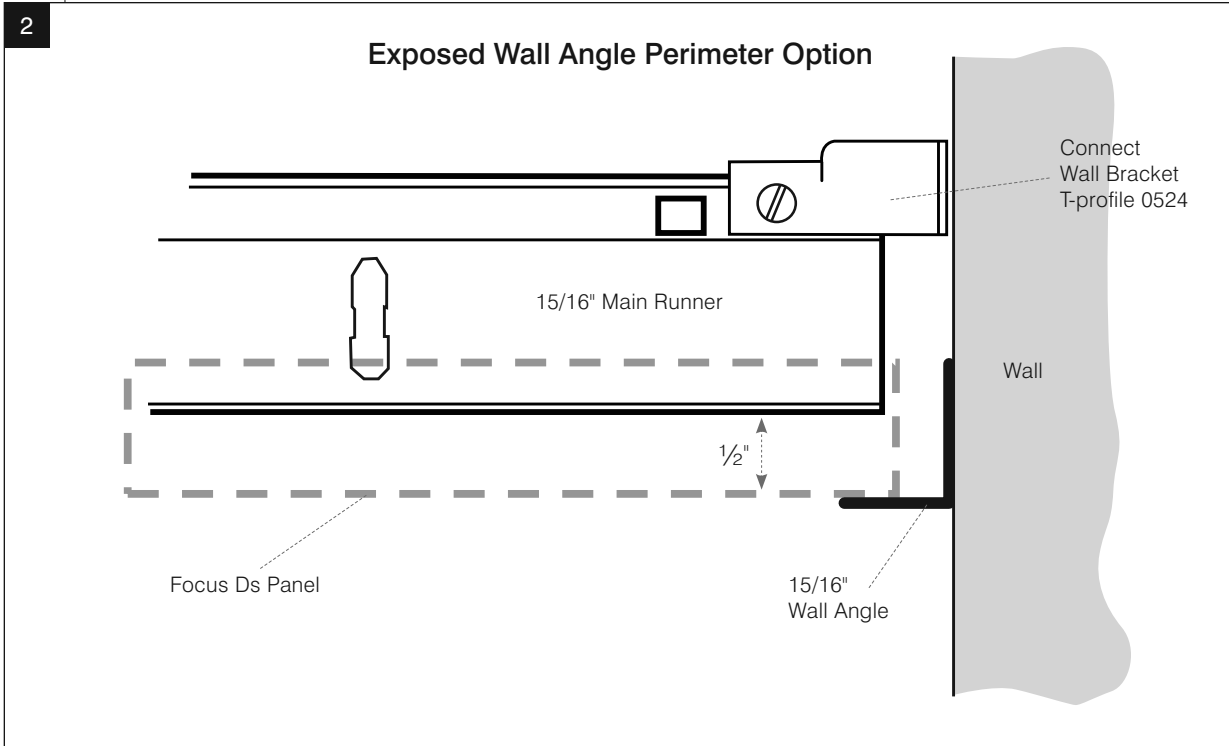

Installation for Ecophon® Focus™ Ds for 2x2, 2x4, 2x5, 2x6, & 2x8 Panels

4. Install Hangers

- a. Mark lines for each of the main runners (2' on center).
- b. Pull a string line along the path that the first main runner will take.
Attach the line directly below the wall molding.
- c. Hangers are placed every 48" along the main runners, at a max of 24" from the walls.

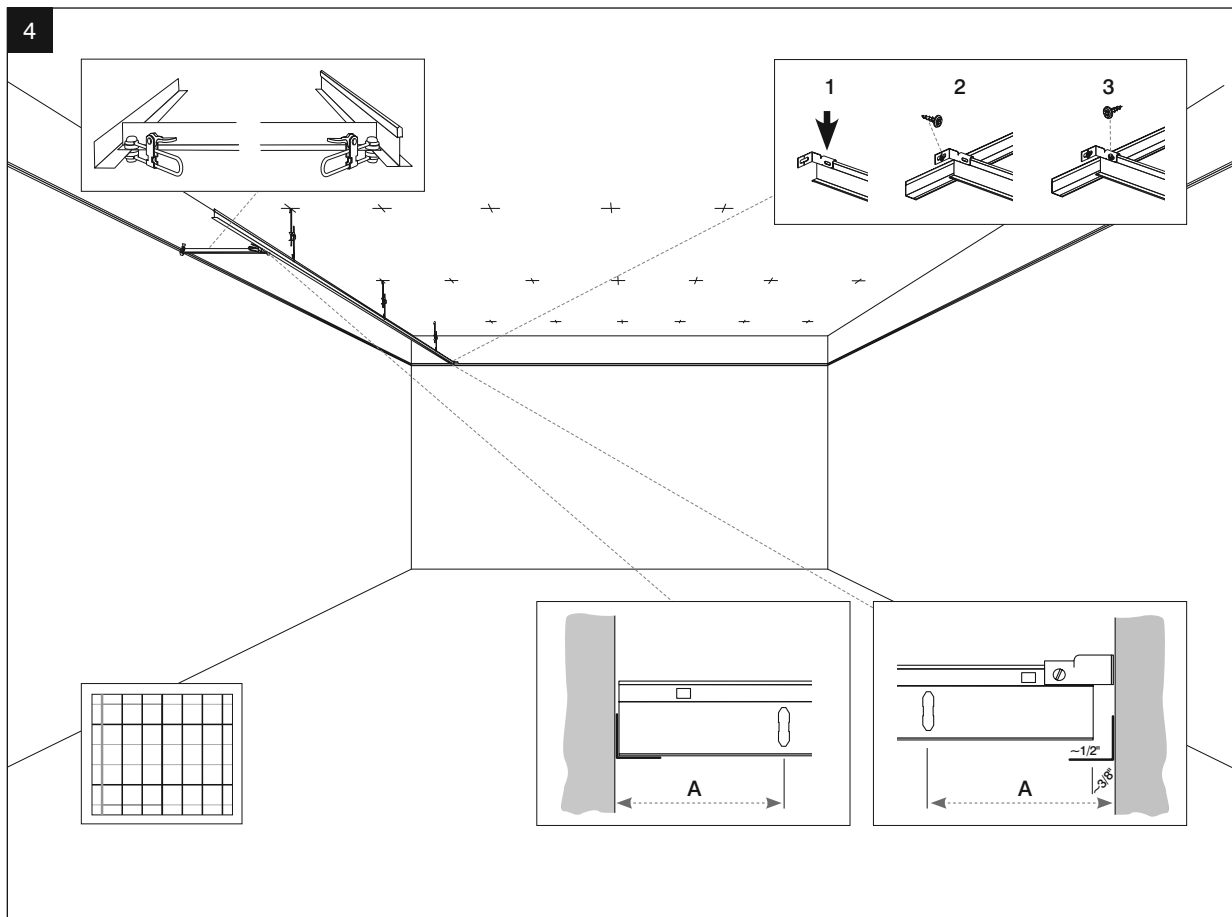

Installation for Ecophon® Focus™ Ds for 2x2, 2x4, 2x5, 2x6, & 2x8 Panels

5. Install the main runners

- a. Install the first section of main runner, with cut edge sitting on the wall molding.
- b. Attach the main runner to wire.
- c. Repeat for the next sections of main runner. (Be sure that the cross tee slots on all main runners line up, or the Connect Space Bar will not install. Be sure that all the main runners are consistently level).
- d. Install the Connect Space Bars 48" on center (max. 24" from walls). Space Bars are 8'2" long and should be staggered 6" to the next cross tee slot in order to create continuous main runner spacing (illustrated in Step 6).
- e. Insert Connect Space Bar Winch through each cross tee slot.

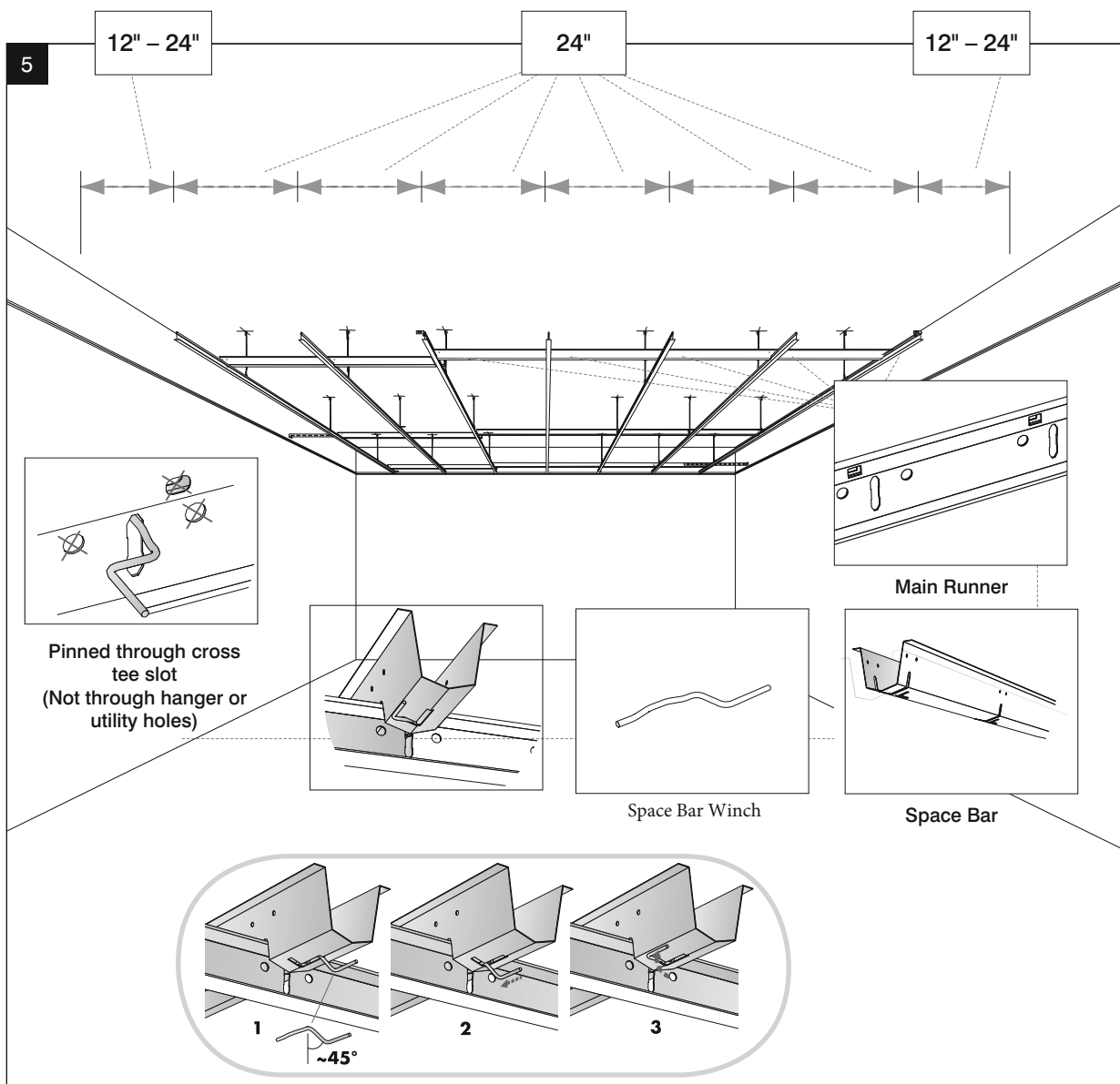

Installation for Ecophon® Focus™ Ds for 2x2, 2x4, 2x5, 2x6, & 2x8 Panels

6. Install Connect Wall Bracket Space Bars
 - a. Check to see if the suspension system is square. Make adjustments as needed.
 - b. Using screws, attach the Connect Wall Bracket Space Bar to the Connect Space Bar, and then attach the Connect Wall Bracket Space Bar to the Wall. For spacing, see step 7.

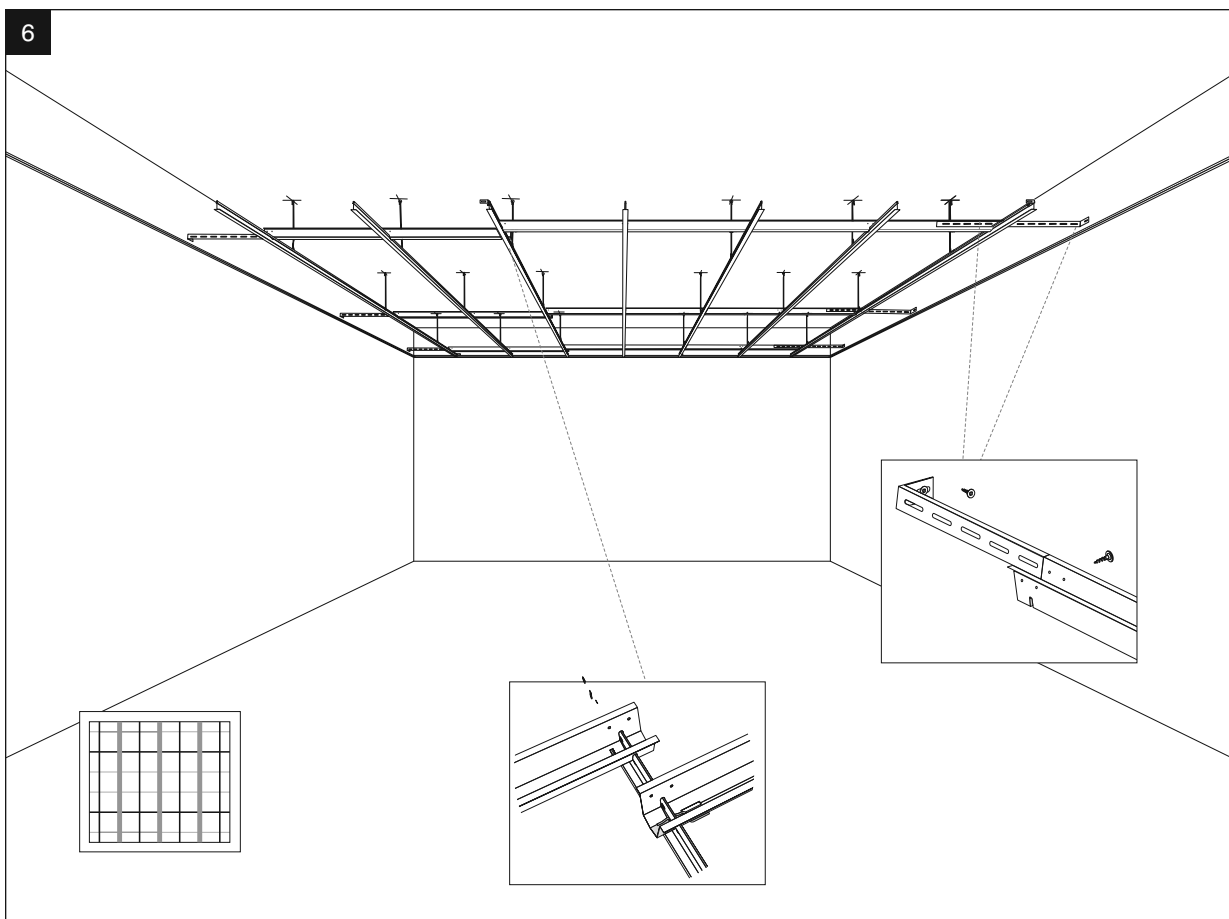

Installation for Ecophon® Focus™ Ds for 2x2, 2x4, 2x5, 2x6, & 2x8 Panels

7. Connect Wall Bracket Space Bars Spacing

- a. Every row of Connect Space Bars should have at least one Connect Wall Bracket Space Bar.
Connect Wall Bracket Space bars should alternate to opposite ends of each run of Space Bars.

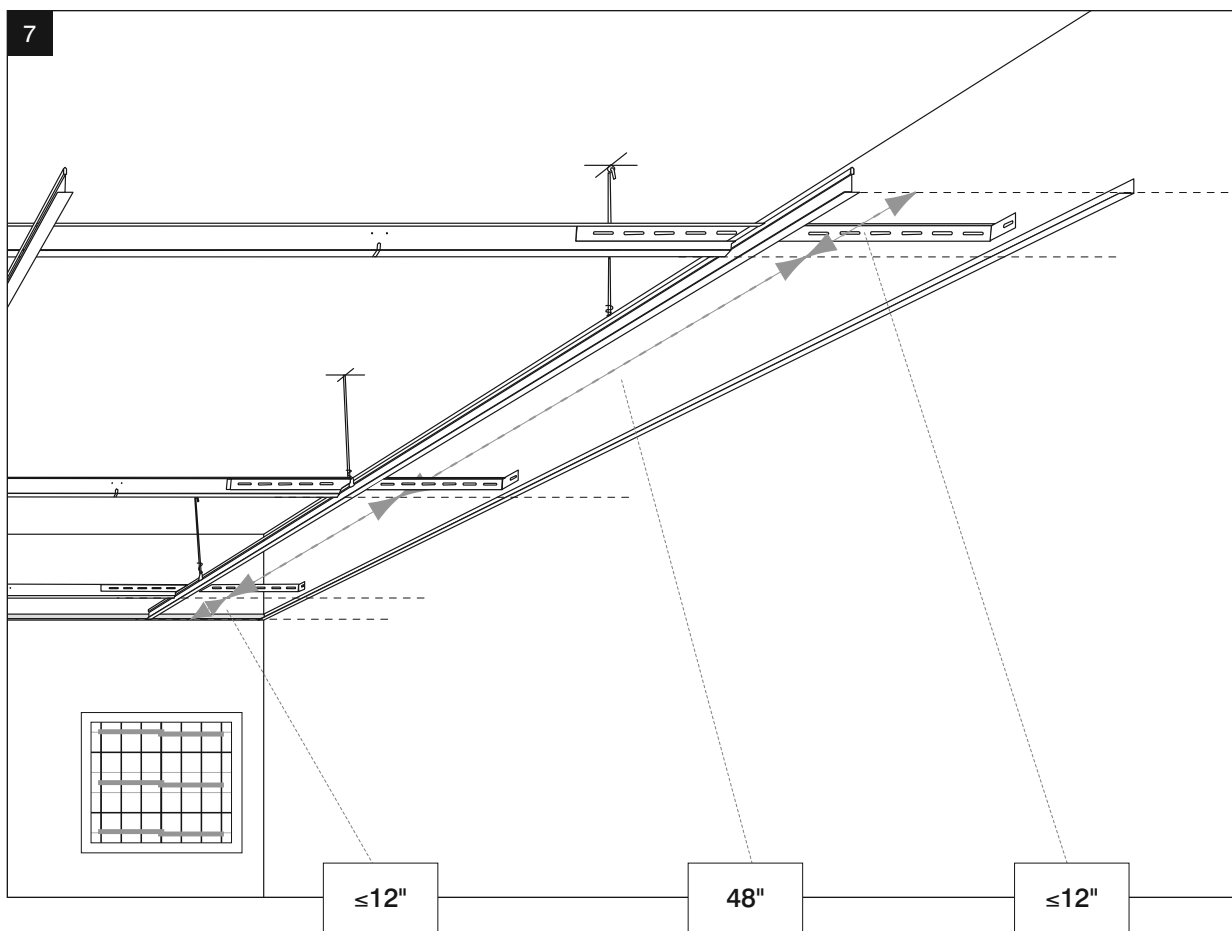

Installation for Ecophon® Focus™ Ds for 2x2, 2x4, 2x5, 2x6, & 2x8 Panels

8. Install Field Panels

(Note: 2'x6' and 2'x8' panels require two people to install each panel).

Before you begin installing the panels, you must understand that Focus Ds panels have 2 supporting edges and 2 non-supporting edges. As illustrated below:

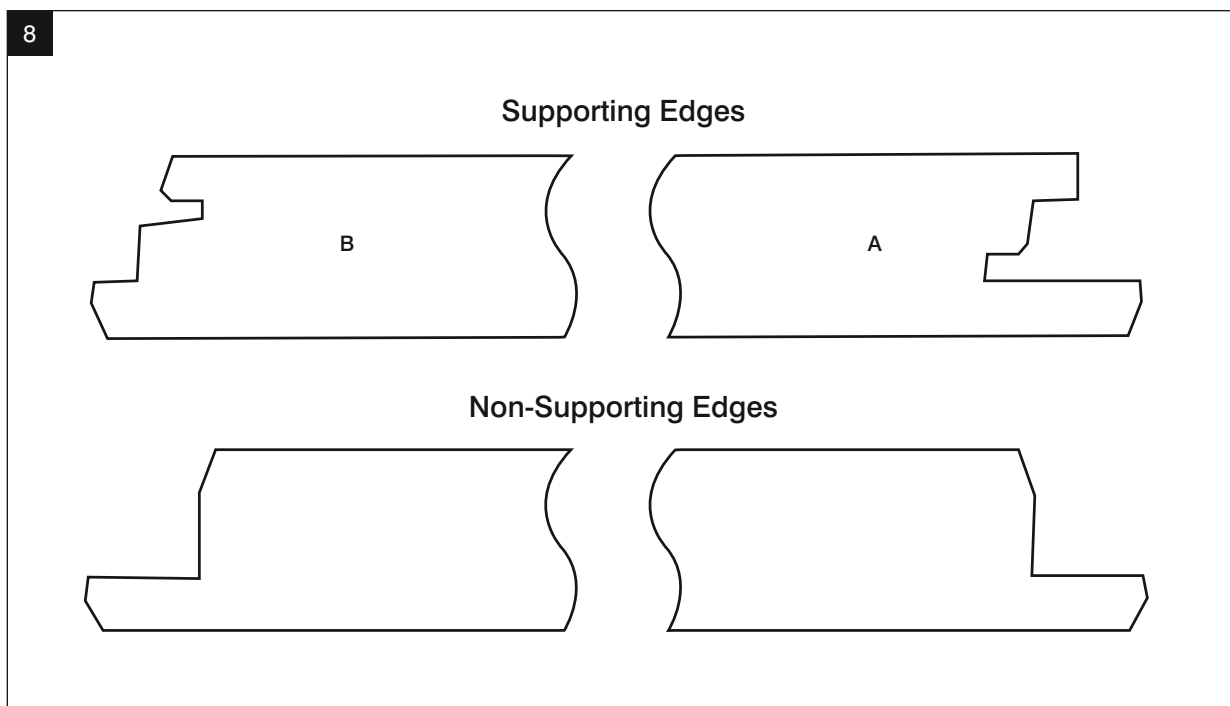

Please note that the long sides of the panels are always the supporting sides.

- a. Install temporary string lines along the path where the panel joints will meet.
(since there are no cross tees as a reference)
- b. **Wear white cotton gloves, so that the dirt and oil from your hands do not get on the panels. (If gloves become soiled, replace them immediately).**
- c. Start installing panels in the middle of the field.
- d. For detailed instructions on how to install Focus Ds Panels, follow step 8-1, 8-2, & 8-3.

Installation for Ecophon® Focus™ Ds for 2x2, 2x4, 2x5, 2x6, & 2x8 Panels

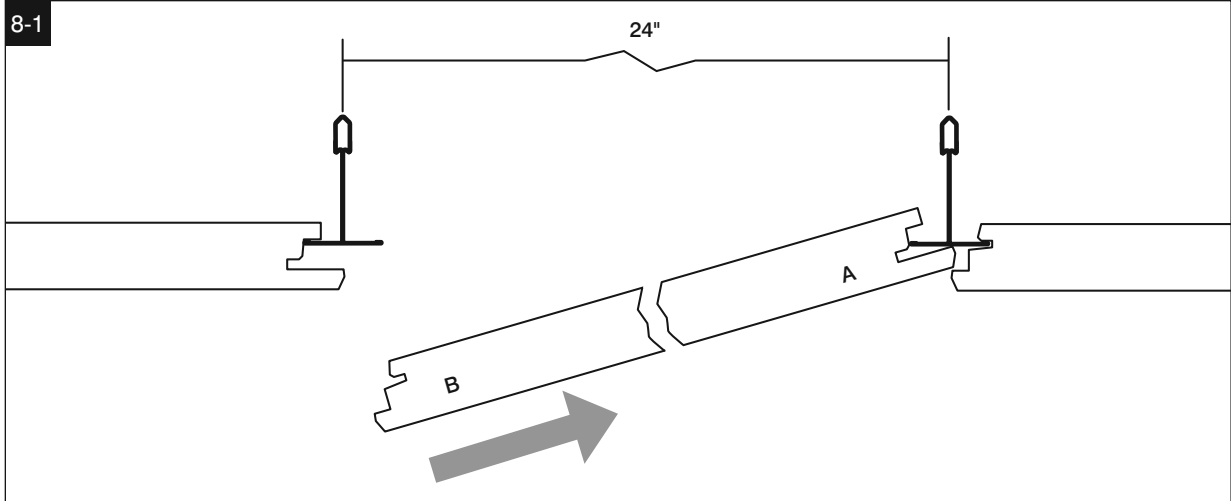

Step 1: Place the leading edge (A) into the grid as shown, making sure that the wider (deeper) groove is pushed as far as it can go into the flange. (This will allow the room to ensure that the trail edge (B) clears the grid on the opposing side).

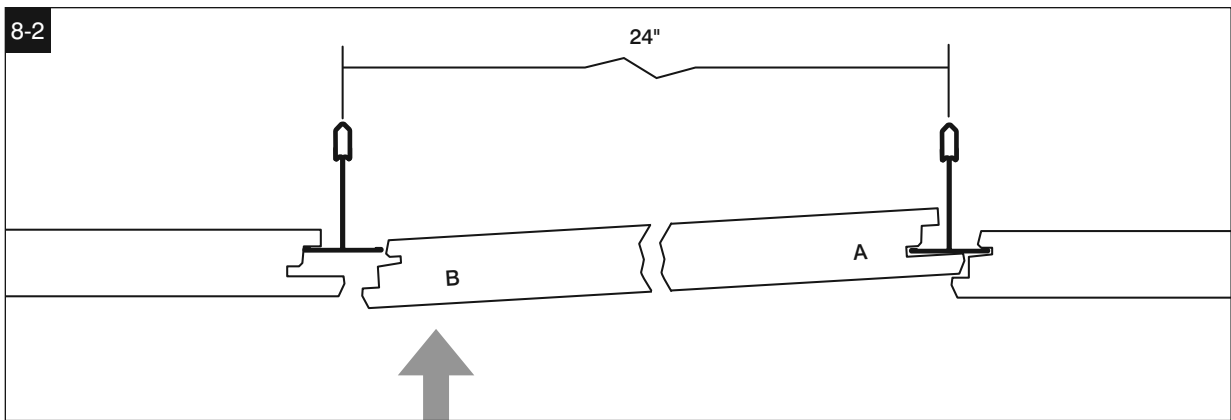

Step 2: While keeping light pressure toward edge (A), push edge (B) up to begin to engage the flange on the grid.

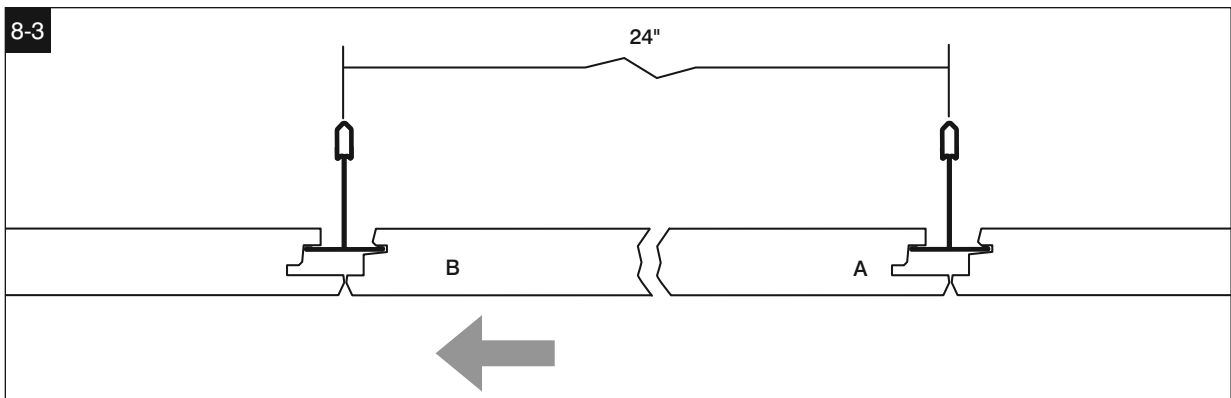

Step 3: Slide panel toward edge (B). Edge (A) will move into its finished resting place. To remove the panel, lift up gently on edge (A) and perform the process in reverse.

Installation for Ecophon® Focus™ Ds for 2x2, 2x4, 2x5, 2x6, & 2x8 Panels

Install Border Panels

To understand installing border panels/edge treatment, consult the appropriate directions below.

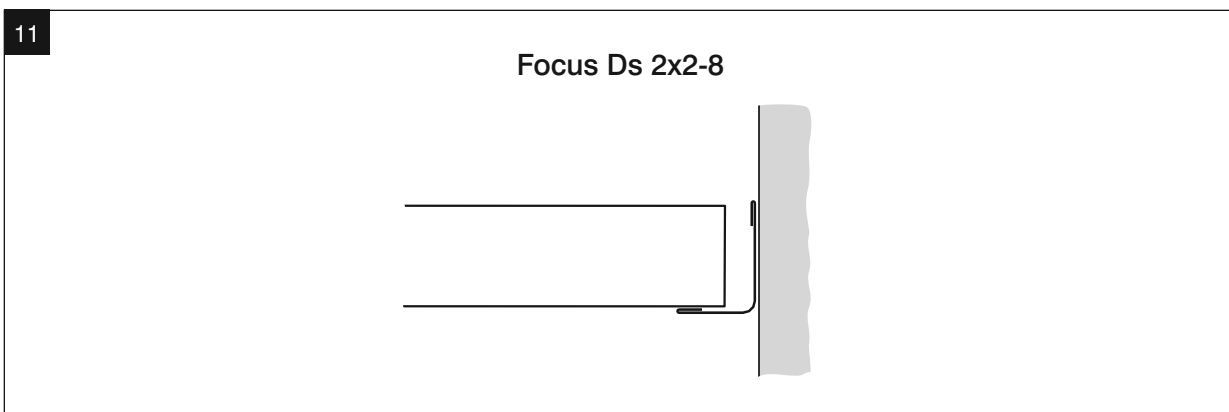
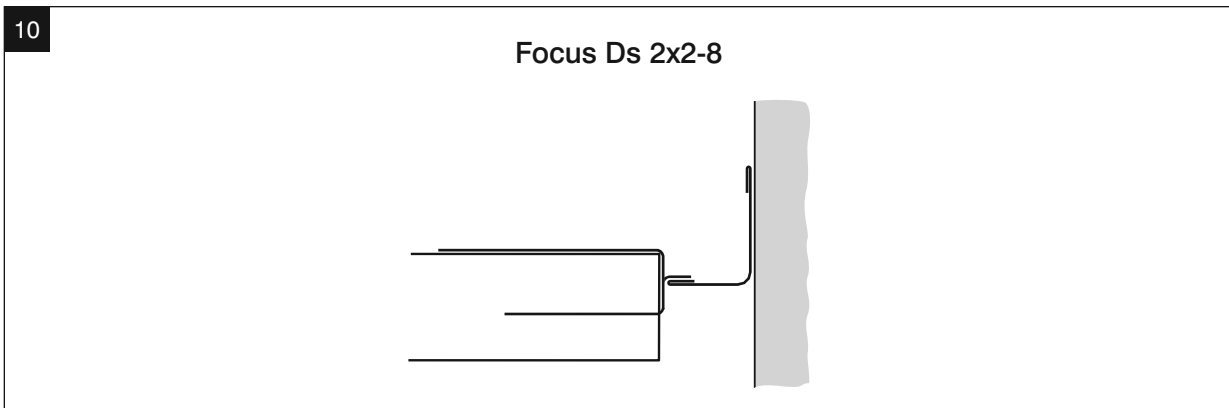
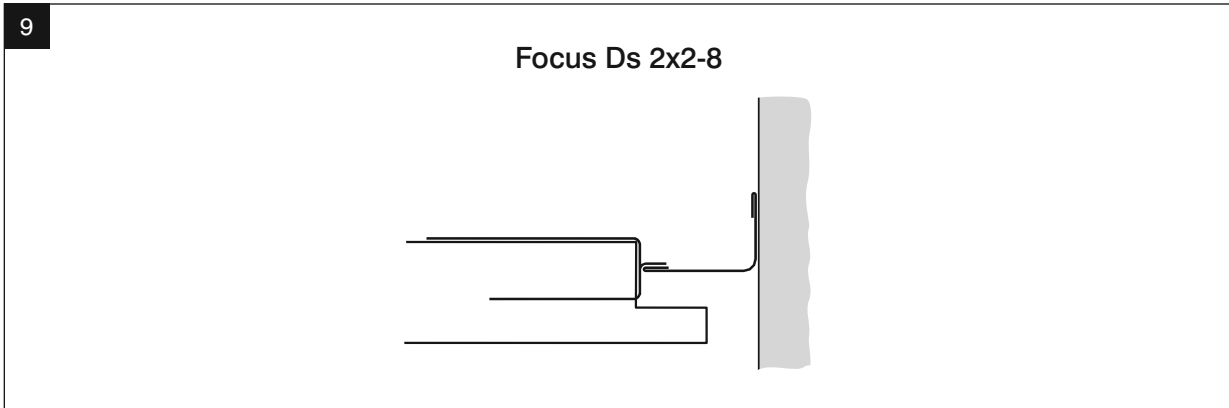

Installation for Ecophon® Focus™ Ds for 2x2, 2x4, 2x5, 2x6, & 2x8 Panels

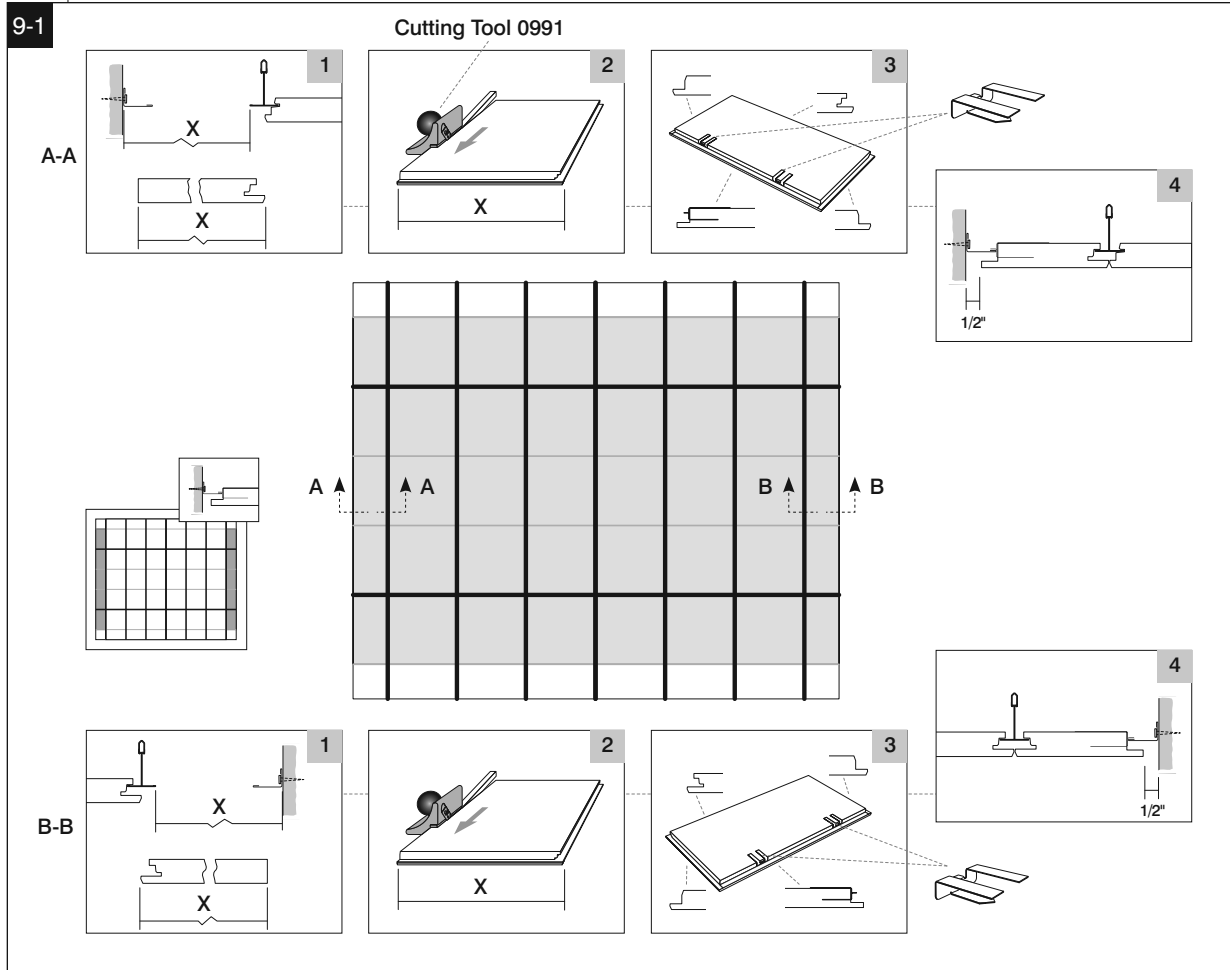

Notes:

- The Focus Ds System is designed so that 1/2" of the wall molding is visible from below. The dimension of molding exposed is at the Architect's discretion. If the Architect does not specify a different dimension, these directions will result in a 1/2" gap around the border.
- For more accurate cut edges, measure at least twice at each end of the panel, so the cut edge may better follow the contour of the wall.
- Straight cuts should be made using a razor knife and a straight edge.
- The Connect DG Cutting Tool 0991 cuts a 9/16" by 9/16" rabbet. The shim attached to the tool should remain when cutting 3/4" panels.
- Connect DG20 Support Clip 0547 should be spaced every 12"-18".
- Connect Edge Sealant 0691 is used as required. Avoid applying edge sealant to the surface of the panel.

Installation for Ecophon® Focus™ Ds for 2x2, 2x4, 2x5, 2x6, & 2x8 Panels

9-2

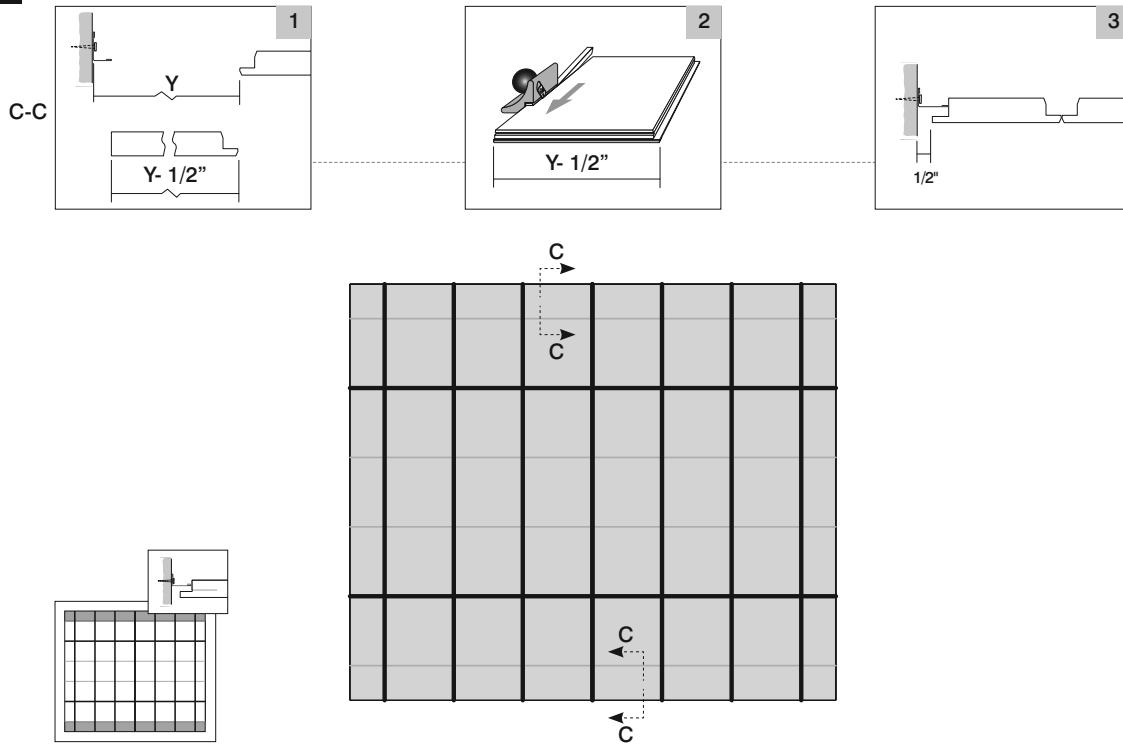

Installation for Ecophon® Focus™ Ds for 2x2, 2x4, 2x5, 2x6, & 2x8 Panels

10-1

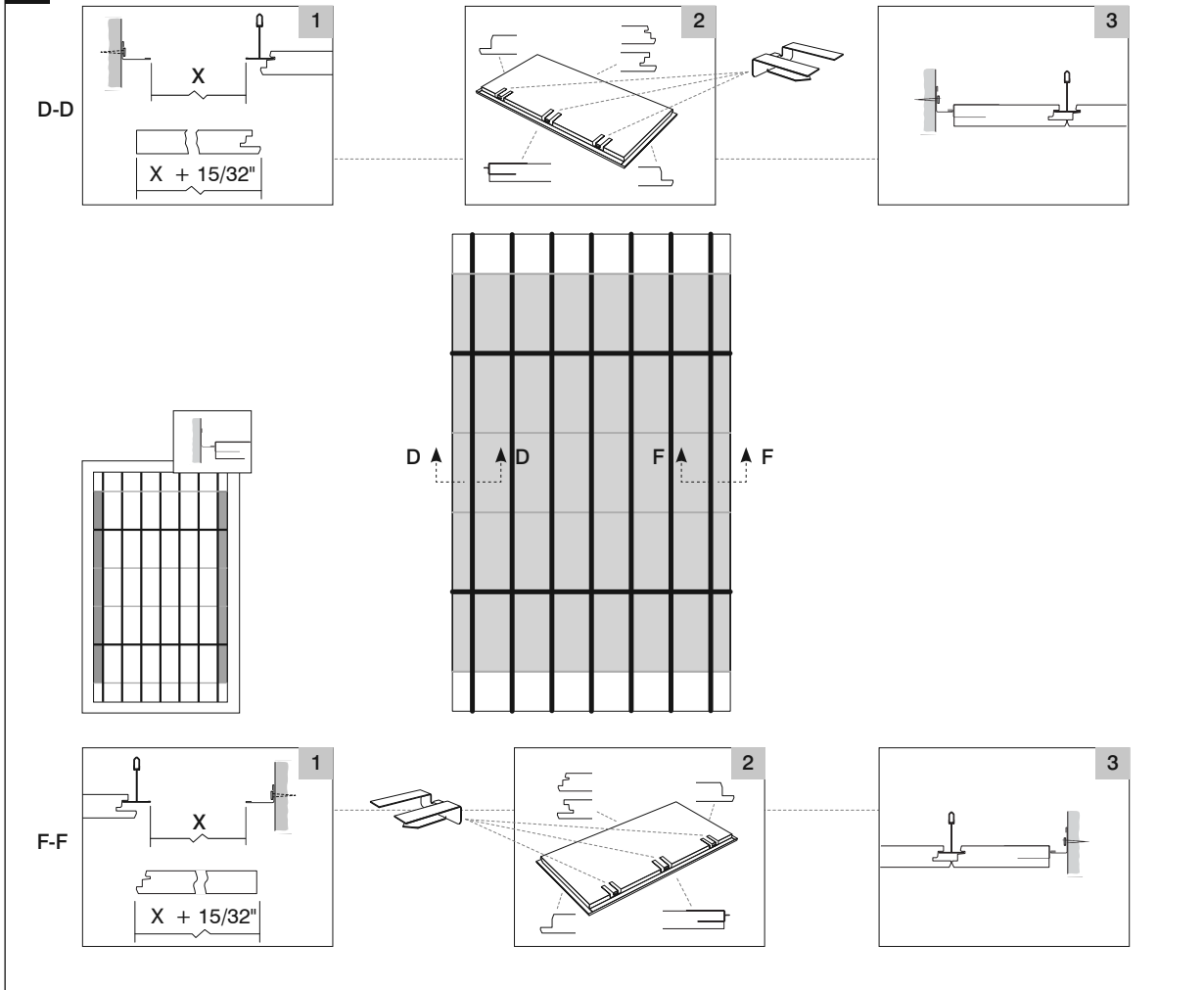

Notes:

- For more accurate cut edges, measure at least twice at each end of the panel, so the cut edge may better follow the contour of the wall.
- Straight cuts should be made using a razor knife and a straight edge.
- Connect DG20 Support Clip 0547 should be spaced every 12"-18".
- Connect Edge Sealant 0691 is used as required. Avoid applying edge sealant to the surface of the panel.

Installation for Ecophon® Focus™ Ds for 2x2, 2x4, 2x5, 2x6, & 2x8 Panels

10-2

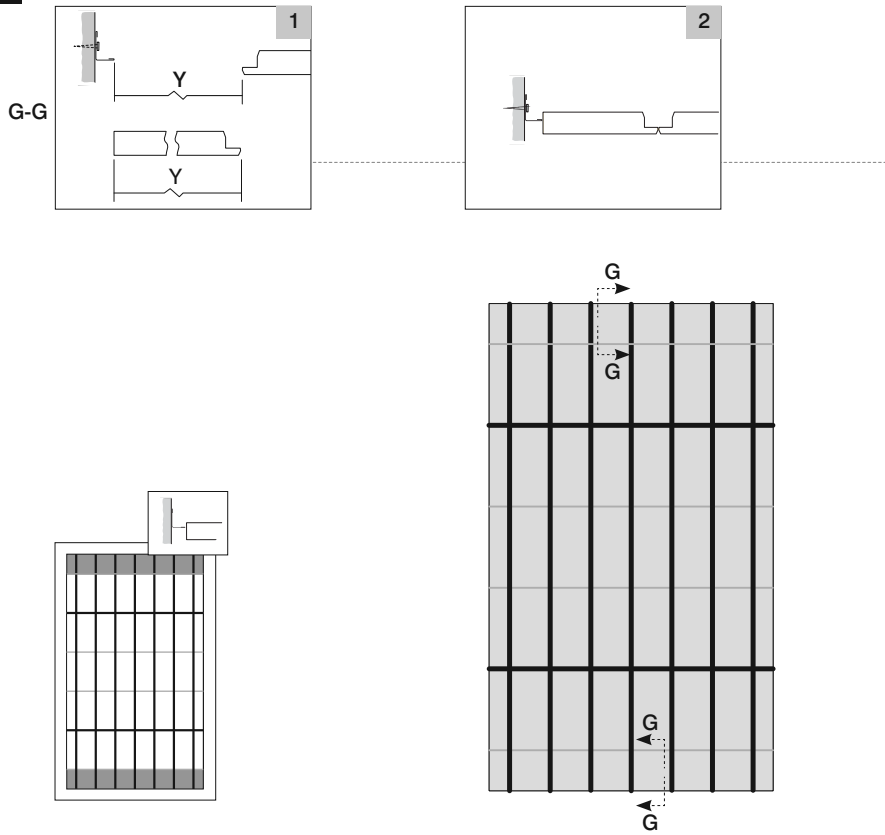

Installation for Ecophon® Focus™ Ds for 2x2, 2x4, 2x5, 2x6, & 2x8 Panels

11-1

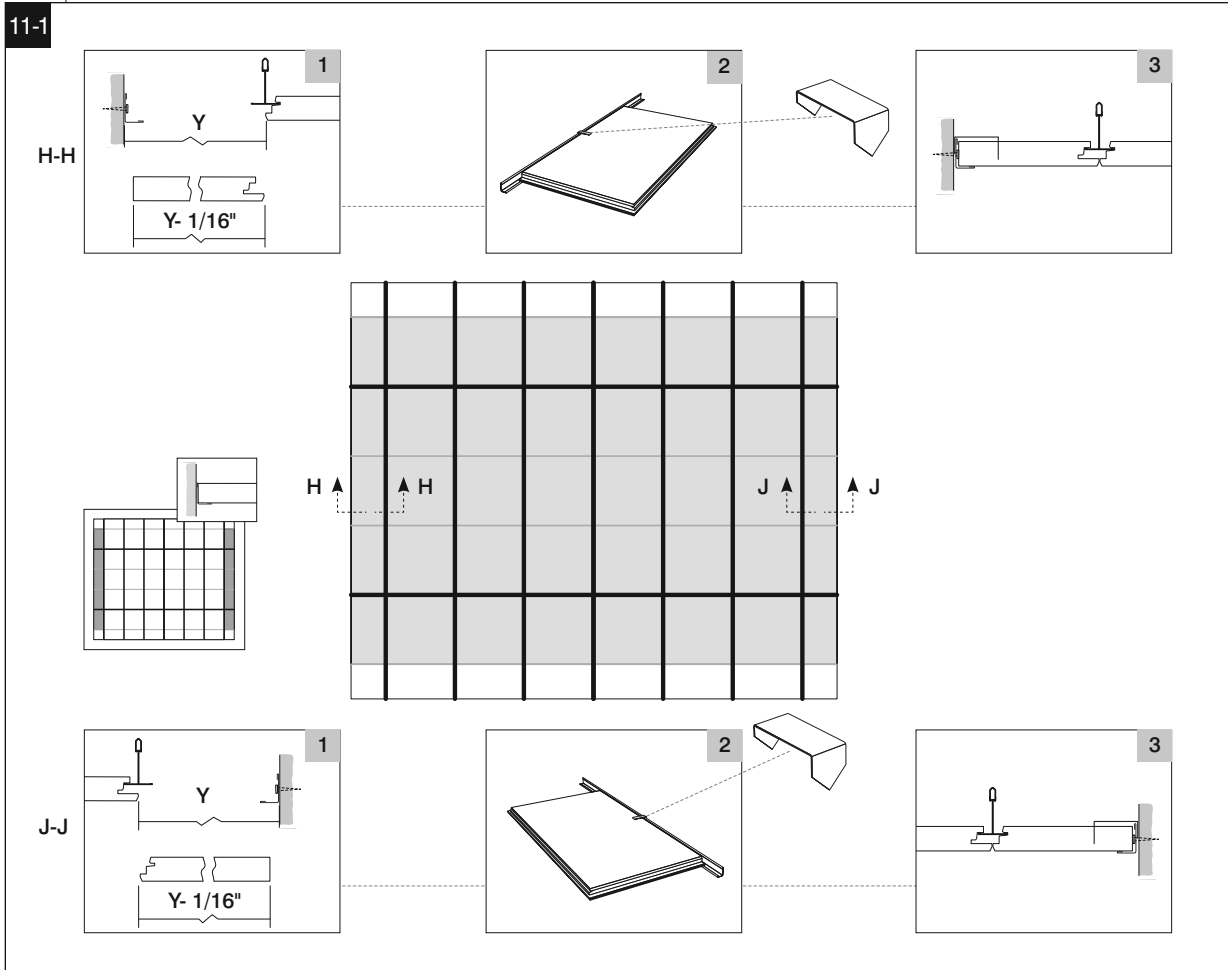

Notes:

- Ecophon Connect Perimeter Tile Clip can be used at the perimeter to keep square cut panels tight to the wall, and secure on the wall angle.
- Straight cuts should be made using a razor knife and a straight edge.

Installation for Ecophon® Focus™ Ds for 2x2, 2x4, 2x5, 2x6, & 2x8 Panels

11-2

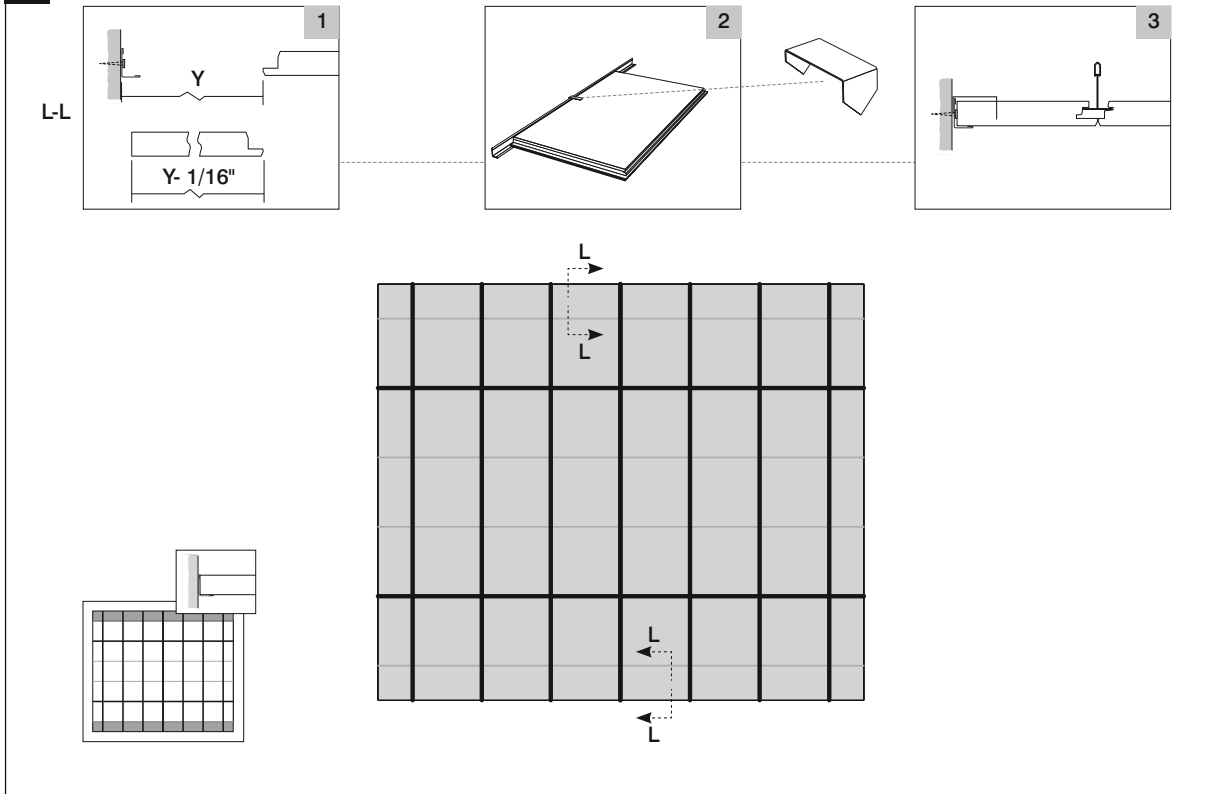

For Product and Installation Questions:

Call 1-800-233-8990 (Monday-Thursday: 7:30 am – 6:30 pm, Friday: 7:30 am – 6:00 pm EST);

English, Spanish and French speakers available. Or email: ceilingstechnicalservices@certainteed.com

ASK ABOUT ALL OF OUR OTHER CERTAINTEED® PRODUCTS AND SYSTEMS:

ROOFING • SIDING • TRIM • DECKING • RAILING • FENCE
GYPSUM • CEILINGS • INSULATION

www.certainteed.com/ceilings

CertainTeed Corporation
20 Moores Road
Malvern, PA 19355

Professional: 800-233-8990
Consumer: 800-782-8777

© 2/16 CertainTeed Corporation
CTC-02-123