

# Recommendations for Installation in Residential and Other Light-Frame Construction

## Fiber Glass Building Insulation

**NAIMA**  
NORTH AMERICAN INSULATION  
MANUFACTURERS ASSOCIATION



[www.naima.org](http://www.naima.org)

# Contents

|   |   |                                       |    |
|---|---|---------------------------------------|----|
| <b>What Does Thermal Insulation Do?</b>         | 1 | Floors                                | 7  |
| Heat Control                                    | 1 | Basement Walls                        | 8  |
| Sound Control                                   | 1 | Crawl Space Walls                     | 9  |
| Moisture Control                                | 1 | <b>Insulating Around Obstructions</b> | 9  |
| <b>What is Fiber Glass Insulation?</b>          | 1 | General                               | 9  |
| <b>Where is Insulation Installed?</b>           | 1 | Electrical                            | 9  |
| <b>How Is Insulation Labeled?</b>               | 2 | Plumbing                              | 10 |
| <b>Consumer Information</b>                     | 2 | Air Ducts                             | 10 |
| FTC Home Insulation Rule                        | 2 | Openings Through Building Sections    | 10 |
| <b>Types of Fiber Glass Building Insulation</b> | 2 | <b>Vapor Retarders</b>                | 11 |
| Faced Insulation                                | 2 | What is a Vapor Retarder?             | 11 |
| Unfaced Insulation                              | 3 | What Does a Vapor Retarder Do?        | 11 |
| Insulation Sizes                                | 3 | Vapor-Retarder-Faced Insulation       | 11 |
| <b>Scheduling Insulation Work</b>               | 3 | When Is a Vapor Retarder Required?    | 11 |
| <b>Installation Techniques</b>                  | 3 | Cautions                              | 11 |
| Faced Insulation                                | 3 | Other Vapor Retarder Materials        | 12 |
| Unfaced Insulation                              | 4 | Ground Covers                         | 12 |
| Lay-In  | 4 | <b>Clothing and Equipment</b>         | 12 |
| Narrow-Framed Cavities                          | 4 | Clothing                              | 12 |
| Packing or 'Chinking'                           | 5 | Equipment                             | 12 |
| Cantilevered Overhangs                          | 5 | <b>What NAIMA Tells Consumers</b>     | 12 |
| Interior Soffits and Drops                      | 5 | <b>Material Specifications</b>        | 13 |
| Insulating at Bridging                          | 5 | <b>Thermal Recommendations</b>        | 13 |
| Double Wall                                     | 6 |                                       |    |
| <b>Installation Instructions</b>                | 6 |                                       |    |
| General   | 6 |                                       |    |
| Ceilings  | 6 |                                       |    |
| Cathedral Ceilings                              | 7 |                                       |    |
| Attic Rooms                                     | 7 |                                       |    |
| Walls   | 7 |                                       |    |



# What Does Thermal Insulation Do?

## Heat Control

Insulation resists the flow of heat. Heat is a form of energy. By reducing heat flow in a properly insulated building, less energy is used for winter heating and summer cooling. Energy costs are high today and will be even higher in the future. Insulating today will help save both dollars and energy. Savings vary. Find out why in the seller's fact sheet on R-values. The higher the R-value, the greater the insulating power.

## Sound Control

Insulation reduces sound transmission. An insulated floor, wall or ceiling will have an improved Sound Transmission Class (STC) compared with a similar building section with no insulation. As an example, 3-1/2 inches of fiber glass insulation in a wall can improve the STC from 4 to 11 points, depending upon construction details.

## Moisture Control

A vapor-resistant membrane (commonly called a vapor retarder) attached to batt or roll insulation, or installed separately, decreases the possibility of moisture vapor condensing to water within the structure.

# What is Fiber Glass Insulation?

The basic materials, sand and glass, are melted and then spun into wool-like fibers. These are processed into batt or roll insulation, with or without facings, and in loose form for pneumatic applications. See ASTM C 665 (Mineral Fiber Blanket Thermal Insulation for Light Frame Construction and Manufactured Housing). For more information on ASTM Standards, ask for NAIMA Facts #8.

# Where is Insulation Installed?

Batts and rolls are designed for use in framing members of residential and other light-frame constructions. Standard widths are available for 16 and 24-inch on-center spacing; special widths are available for steel studs. A batt is a pre-cut piece of insulation, usually 47 to 96 inches in length. Rolls are available in lengths up to 70 feet.

Figure 1

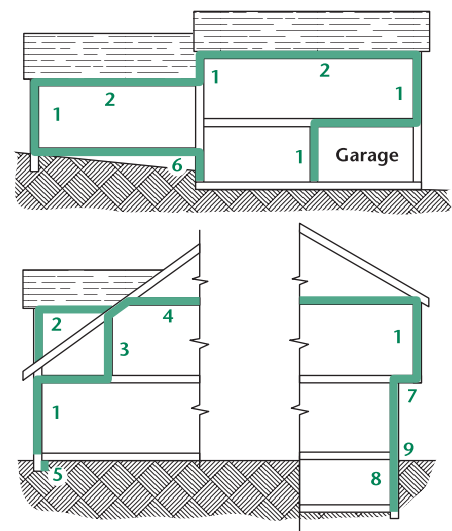

## Areas To Insulate

(Numbers refer to locations in Figure 1.)

1. Exterior walls. Sections sometimes overlooked are walls between living spaces and unheated garages or storage rooms, dormer walls, and the portions of walls above ceilings of adjacent lower sections of split-level homes.
2. Ceilings with cold spaces above, including dormer ceilings.
3. Knee walls of attic spaces finished as living quarters.
4. Sloped walls and ceilings of attic spaces finished as living quarters.
5. Perimeters of slabs on grade.
6. Floors above vented crawl spaces. Insulation may also be placed on crawl space floors and walls.

7. Floors over unheated or open spaces such as over garages or porches. Floors over unheated basements. The cantilevered portions of floors.
8. Basement walls.
9. Band or header joists, the wall sections at floor levels.
10. Interior walls, ceilings and floors where sound control is desired. *(Not shown on Figure 1.)*

Although they are not shown, common walls and floors between separately heated apartment or townhouse units should be insulated. In addition to its thermal benefit, the insulation improves sound attenuation and fire resistance.

## How Is Insulation Labeled?

Fiber glass building insulation is identified and labeled by R-value. “R” stands for resistance to heat flow. (The higher the R-value the greater the insulating power. Ask your seller for the fact sheet on R-values.) The R-values are printed on the insulation batts and rolls. Most common R-values of batts and rolls are 11, 13, 15, 19, 21, 22, 25, 30, and 38. R-values can be added. If, for example, a ceiling requires R-38 insulation, two layers of R-19 batts or rolls can be used.

*Note: When batts or rolls are compressed to less than normal thickness during installation, the rated resistance value will be reduced.*

## Consumer Information

### FTC Home Insulation Rule

The United States Federal Trade Commission’s (FTC) Labeling and Advertising of Home Insulation Rule requires installers to provide each customer (builder or consumer) with a signed and dated contract or receipt for the insulation installed. This applies to all insulation except loose-fill and aluminum foil (16 C.F.R. §460.17). The receipt for loose-fill must show the coverage area, initial installed thickness, minimum settled thickness, R-value, and the number of bags used (16 C.F.R. §460.17). The manufacturer must also pro-

vide a manufacturer’s fact sheet. Installers must have this information and show it to customers before they agree to buy the insulation.

A new-home seller must put the following information in every sales contract: the type, thickness, and R-value of the insulation that will be installed in each part of the house (16 C.F.R. §468.16).

## Types of Fiber Glass Building Insulation

### Faced Insulation

Batts and rolls are available with facings already attached. The facing material is usually a vapor retarder. Vapor retarding facings usually consist of asphalt-coated kraft paper, aluminum foil or plastic film. A vapor retarder’s purpose is to resist the movement of moisture vapor to cold surfaces where it could condense to liquid water.

The facings extend over the sides of the insulation to provide strengthened flanges that can be stapled to wood framing to hold the insulation in place where recommended by the manufacturer. (Some faced products may be pressure fit between framing without stapling.) (See Figure 2.)

Figure 2

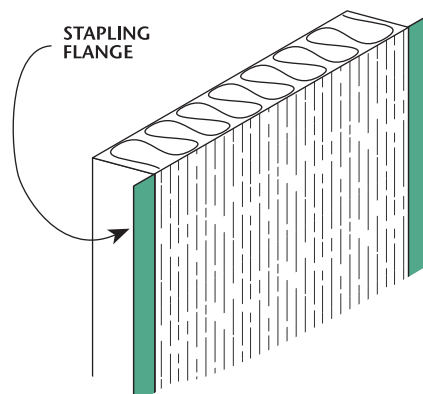

Carefully read the manufacturer’s directions printed on packaging of batt or roll insulation to be sure the material is correctly installed.

### Unfaced Insulation

Unfaced wall insulation is sometimes made wider to permit installation by pressure fitting between

either wood or metal framing. No fastening is required if the insulation material is held in place on all four sides like a typical wall cavity. The insulation in knee walls (see figure 1, item 3) should be held in place with wire lacing or some equivalent method to prevent the insulation from falling out of the wall cavity over time. A separate vapor retarder may be required when unfaced insulation is used.

## Insulation Sizes

Insulation is packaged as batts or rolls and is available in a variety of sizes. Not all sizes are produced by every manufacturer. The table below represents common material sizes.

| Nominal Dimensions Available |                              |                 |
|------------------------------|------------------------------|-----------------|
|                              | Batts                        | Rolls           |
| Lengths                      | 47" (1194 mm), 48" (1219 mm) | 39'2" (11.94 M) |
|                              | 90" (2286 mm), 93" (2362 mm) | 40' (12.19 M)   |
|                              | 94" (2388 mm), 96" (2438 mm) | 70'6" (21.49 M) |
| Widths                       | 11" (279 mm), 15" (381 mm)   | 11" (279 mm)    |
|                              | 15¼" (387 mm), 16" (406 mm)  | 15" (381 mm)    |
|                              | 23" (584 mm), 23¼" (590 mm)  | 23" (584 mm)    |
|                              | 24" (610 mm)                 |                 |

## Scheduling Insulation Work

Construction debris must be removed from spaces to be insulated. Insulation should be installed just before the interior finish is applied. This means that the following-listed work, as applicable, has been performed.

- Foundation walls are in place. Sidewalls, floors, roof and ceiling have been framed.
- Roofing is finished and doors, windows, subflooring and sheathing are in place.
- Plumbing, wiring (including telephone and other low-voltage wiring) and heating, ventilating and air conditioning work have been completely roughed in. If any part of this work is done following the installation of the insulation, the vapor retarder may be damaged and gaps may be made in the insulation. Openings in the insulation or vapor retarder will reduce the effectiveness of the material.

## Special Situations:

In some constructions, it will be necessary to install part of the insulation before the sheathing is applied or before the mechanical or electrical work is roughed-in. These are areas that will be impossible or difficult to insulate later, such as where plumbing fixtures are next to outside walls and at soffits or overhangs.

Where attics are accessible, ceiling insulation may be installed from the attic space after the ceiling finish is in place. Many roofs, however, are of shallow pitch, making it difficult to insulate the outer edges of the ceiling from above. The work, therefore, is best accomplished before the ceiling finish is installed.

Floors over unheated spaces that will not receive a bottom surface may be insulated at any time after the subflooring and mechanical and electrical work are complete.

## Installation Techniques

### Faced Insulation

There are three commonly accepted methods of installing faced insulation in wood framing members:

#### *Inset Stapling*

When insulating side walls, place the insulation in the cavity and check to be sure it completely fills the cavity, top to bottom. When insulating ceilings, be sure that each batt is butted closely to the next one before fastening. Gently press the insulation at the sides into the framing cavity, usually about 3/4 inch, until the outside edge of the flange is flush with the face of the framing. When inset stapling insulation between inclined or vertical framing members, as in cathedral ceilings or walls, start stapling at the top and work down. Use enough staples to hold the insulation firmly in place and avoid gaps and "fishmouths" between flanges and framing (Refer to Figure 3A).

It is recommended that a single batt be used in side walls. However, when insulating with 47" or 48" batts, make sure the two pieces are butted snugly together. Use R-11, R-13 or R-15 with 2 x 4 stud construction and R-19, R-21 or R-22 with 2 x 6 studs. Remember, compressing insulation to fit a cavity will result in some loss of R-value.

## Face Stapling

Place the insulation between framing members and check to be sure it fits the cavity at both ends. With facing material flush with the face of the framing, the flanges will overlap the framing. Staple the flanges to the face of the framing, using enough staples to hold the insulation firmly in place and avoid gaps and fishmouths. The flange of the faced insulation placed in the next cavity will overlap the previously stapled flange. (Refer to Figure 3B.) When more than one batt is used, pieces must be snugly butted.

Figure 3

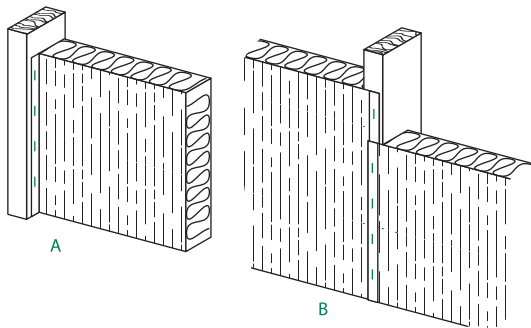

## Inset or Face Stapling?

Both methods are widely used and can provide acceptable performance. Inset stapling is usually preferred by the wall finish trades because it allows adhesive application of wall board. Most commonly used attached vapor retarders are flammable and should not be left exposed. During construction they should be covered with the interior finish material as soon as possible.

## Pressure Fit – No Stapling

Most manufacturers of high-performance batts state that these products do not have to be stapled in place. Consult individual manufacturers' installation instructions. The higher density of these products help hold them in place without a noticeable loss in the moisture protection of the vapor retarder. To install faced products by pressure fit, gently place the insulation into the cavity space between framing. Make sure the insulation facing is flush with the face of the stud. The insulation must fit snugly at the sides and ends.

## Unfaced Insulation

To install unfaced insulation, gently place the insulation into the cavity space between framing members. It is important that insulation be correctly sized for the cavity and fit snugly at the sides and ends. No fastening is required if the insulation material is held in place on all four sides like a typical wall cavity. The insulation in knee walls (see figure 1, item 3) should be held in place with wire lacing or some equivalent method to prevent the insulation from falling out of the wall cavity over time.

*Note: Wherever batts or rolls of any type are too short to fill a stud cavity, a piece should be cut to size to fill the gap. When insulation is too long, it should be cut to fit properly, not doubled over or compressed.*

## Lay-In

After the ceiling finishing material has been applied, faced or unfaced batts or rolls can be laid between framing members and gently pressed into place. Ceiling insulation is held in place by gravity. Vapor retarder facings should face down in ceilings in most climate areas.

There are four techniques for holding insulation in place between floor joists. These are described in the Installation Instructions section which starts on page 6.

## Narrow-Framed Cavities

Insulate non-standard-width framed spaces by cutting the insulation and facing about an inch wider than the space to be filled. As an example, to inset staple a batt or roll into a 9-inch stud cavity, cut the insulation 10 inches wide. Staple the uncut flange as usual. Pull the facing on the cut side to the other stud and staple through the vapor retarder to the stud. (See Figure 4.)

Figure 4

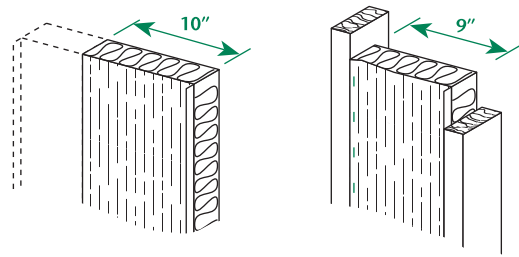

## Packing or 'Chinking'

Special cutting of insulation may be required for less-than-standard width or length cavities or for insulating around window and door framing, stud corners, band joists, and between chimneys and framing. If a faced material is used, and the space, such as at window framing, is narrow, the insulation may be pulled away from the facing in small pieces and stuffed into the narrow space. (See Figure 5.) Small spaces between studs at the corners of buildings and at intersections of partitions and sidewalls should be treated in the same manner before the sheathing is applied. Where a vapor retarder is required, cover the warm-in-winter side of the narrow space with excess vapor retarder facing, duct tape, or polyethylene film. Band joists and headers between floors should be insulated. At the band joist the insulation should be allowed to overlap the sill plate to reduce air infiltration between the sill plate and the foundation.

Figure 5

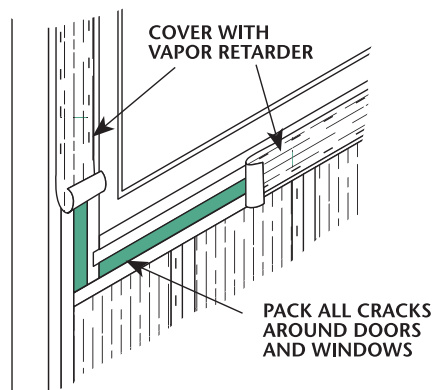

Clearances around fossil-fuel appliances, chimneys and other hot surfaces should meet the requirements of the National Fire Protection

Association (NFPA), building code, or the appliance manufacturers' recommendations. Use only unfaced fiber glass insulation between wood framing and masonry chimneys. Do not place insulation in air spaces surrounding metal chimneys or fireplaces.

## Cantilevered Overhangs

These areas must not be overlooked. If the underside of the cantilever has been closed, insulation must be installed by sliding batts into place from the room below. (See Figure 6.)

Figure 6

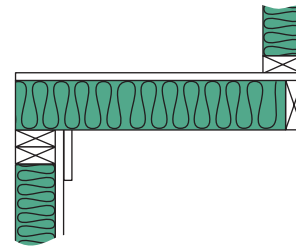

## Interior Soffits and Drops

Interior soffits and drops, usually located over cabinets and bathrooms, should be constructed in a manner to allow proper insulation. Gypsum board or other suitable material can be applied to the underside of ceiling joists to enable the installation of batt or roll insulation.

## Insulating at Bridging

Bridging or cross bracing of ceiling or floor joists is insulated by splitting a batt vertically at the center and packing one half into the lower opening and the other half into the upper opening. (See Figure 7.) Another method is to butt the insulation to the bridging, then fill the bridging space with scrap or loose insulation.

Figure 7

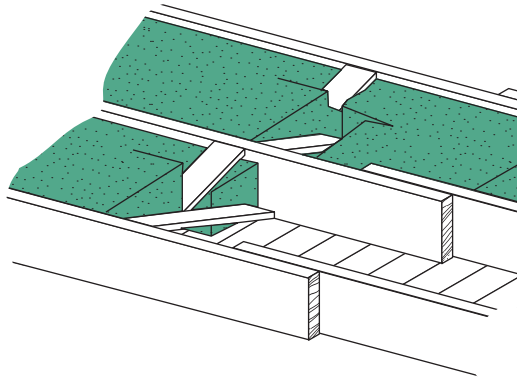

## Double Wall

The super-insulated wall is a double-frame providing a double-depth cavity. The studs are staggered to eliminate thermal and sound paths. Unfaced fiber glass batts are used in the outer wall. A vapor retarder is applied to the inner stud wall either separately or by using faced batts. (See Figure 8.)

Figure 8

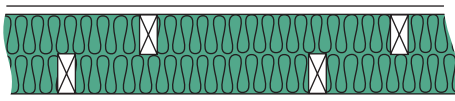

## Installation Instructions

### General

Wherever insulation is installed in a building, it is very important that it fit snugly on all sides. If the insulation is too long for a space, cut it to the correct size. If it is too short, cut a piece to fill the void.

### Ceilings

When ceiling insulation is installed at the same time as wall insulation, it is usually installed from underneath. Batt, faced or unfaced, are installed between ceiling joists and butted together. Faced batts should be stapled to joists unless the manufacturer recommends pressure fit applications and should extend to the outer edge of the exterior wall's top plate. (See Figure 9.)

No stapling is required if insulation is laid in over finished ceilings. The facing should be toward the living space.

Figure 9

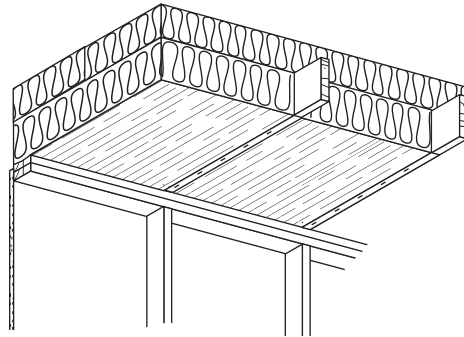

In attics where pre-engineered trusses are used and where more than one layer of insulation is to be applied, the best job is achieved by installing all of the insulation between the bottom chords. In attics with conventional joists and rafters, the first layer of insulation is installed between the joists and should be at least the same height as the joists. (See Figure 9.) The second layer is applied cross-wise to the joists. This method provides the most efficient thermal protection.

It is particularly important that clearance for air movement from vent openings be maintained. If there are soffit vents, there should be about 1-inch of unblocked free air space between the roof sheathing and the insulation. It is important also for the insulation to cover the top plate. Use baffles if necessary to keep the insulation from blocking the passage of air. (See Figure 10.)

Insulation near recessed fixtures should be kept at least 3 inches from the fixtures in accordance with the recommendations of the current National Electrical Code. (This warning does not apply to Type IC fixtures or fluorescent fixtures with thermally protected ballasts.)

Figure 10

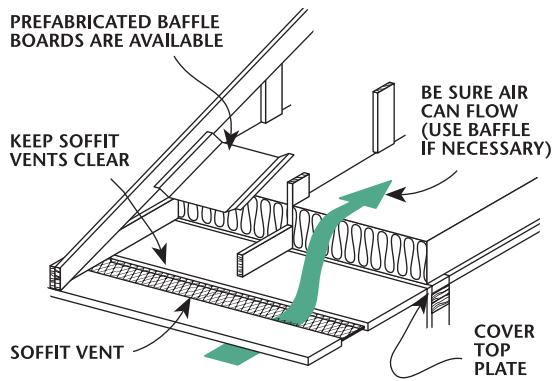

## Cathedral Ceilings

In cathedral ceilings the insulation should be stapled or held in place by pressure against the sides of the rafters. An air space between the insulation and roof sheathing, ventilated at ridge and soffit, is desirable in cathedral ceilings. If unfaced material is used, a separate vapor retarder should be applied facing the living area after the insulation has been installed.

## Attic Rooms

Attics that are used as living spaces should be insulated as shown in Figure 11.

Figure 11

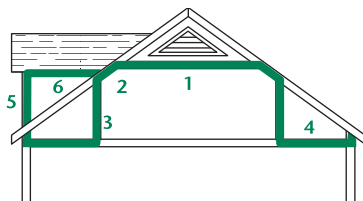

- (1) Between collar beams. (2) Between rafters.
- (3) Knee walls. (4) Ceilings with cold spaces above. (5) Dormer walls. (6) Dormer ceilings.

## Walls

Insulation should fit snugly to the framing on all sides. Even the smallest openings between framing members should be insulated. Recommendations applicable to insulating walls are discussed in Installation Techniques (page 3).

## Floors

Insulation is installed between floor joists, and secured as follows:

### Wire Fasteners

The easiest and most effective method of holding insulation in place is to use straight, rigid wire fasteners, (preferably galvanized,) with pointed ends. The fasteners are made for joist spacings of 12, 16, 18, 20 and 24 inches and may be used against wood, metal, or concrete. The fasteners, which are slightly longer than the joist spacing, are placed by hand between the joists and bowed upwards into the insulation, causing the insulation to press gently against the subflooring. Spacing of fasteners is as required to prevent sagging of the insulation, normally 12" to 24" apart and not more than 6" from ends of batts and rolls. (See Figure 12.)

Figure 12

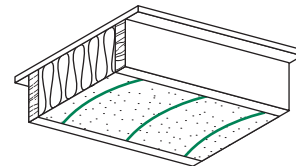

### Mesh or Screen

Galvanized wire, nylon mesh or galvanized screen (chicken wire is also suitable) will hold the insulation in place. After the insulation has been pushed into place the mesh or screen is stapled or nailed to the joist faces. (See Figure 13.)

Figure 13

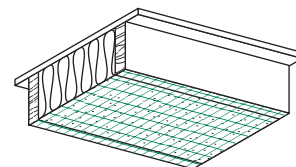

### Wire Lacing

Galvanized, malleable wire may be laced around nails protruding from the faces of the joists or the wire may be stapled to the joists. Wire and nail spacings are as required to prevent sagging of the insulation. (See Figure 14.)

Figure 14

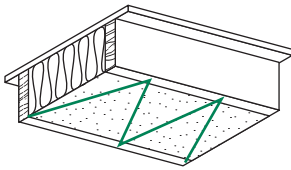

*Note: For homes where the underside of the floor is exposed and readily accessible, such as homes on pilings or certain garage areas, the insulation should be covered with a suitable exterior material to protect it from high winds and physical abuse. Header and band joists should also be insulated.*

When insulating floors where the insulation is less than the thickness of the joists and the method of installation does not hold the insulation up against the subflooring, it will be necessary to insulate the headers or band joists at outside walls. This is because there will be an air space between the top of the insulation and the subfloor that will allow heat to be lost at outside walls. Therefore, it is recommended that the insulation be pushed up to the subfloor. If insulating over an unheated area, the vapor retarder should be in substantial contact with the subfloor. Where the header is parallel with the floor joists it may be necessary to adhere insulation to the header or fill the joist area with insulation. (See Figure 15.)

Figure 15

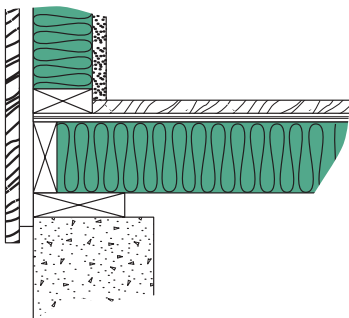

## Basement Walls

Prior to insulating basement walls with any of the following methods, insulate the band joists separately.

## Furring Strips on Masonry or Concrete

Masonry wall insulation ranges from R-3 to R-6, (3/4 to 1-1/2 inches thick) and is unfaced. It is available for use with furring strips 16 and 24 inches on center. After the furring strips are mounted on the wall, the insulation is placed between the furring strips and is held in place by pressure at its sides. Be sure the insulation fits tightly at top and bottom.

If the vertical furring strips are aligned with the floor joists above and do not abut an upper horizontal furring strip, the insulation should extend into the space between the joists to insulate the sill and the header. Where the floor joists run parallel with the wall (no joists meet the header), secure the insulation to the sill and insulate the header separately. If a vapor retarder is desired, polyethylene film or foil-backed gypsum board may be installed.

## Masonry or Concrete with Framing

When insulation of higher R-values (R-11, R-13, R-15, R-19 or R-21) is to be installed on a masonry wall, a separate frame wall may be built of 2 x 4 or 2 x 6 studs.

The top plate is nailed to the underside of the joists or to blocking between joists.

Attachment of the insulation to the framing is the same as for sidewall insulation. Here, too, faced or unfaced insulation may be used, with the vapor retarder applied the same way. Standard vapor retarder facings must be covered with the interior finish material (paneling, 1/2" gypsum board, or the equivalent). Only special low flame-spread vapor retarder facing can be left exposed. Consult individual manufacturers' instructions. (See Figure 16.)

Figure 16

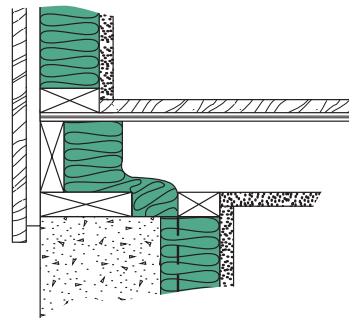

## All Weather Wood Foundation

Insulation is installed in the same way as in framed walls elsewhere in the building.

## Sill Sealer Insulation

Sill sealer is normally available in 50- to 100-foot rolls, up to 6 inches wide and 1 inch thick. Placed between the top of masonry foundations and the sill plate, it resists the flow of heat by reducing air leaks, keeps out insects, and reduces the need for caulking. After laying the sill sealer on the foundation wall, the sill plate is fastened, compressing the insulation to as little as  $\frac{1}{32}$  inch.

## Crawl Space Walls

### Masonry Walls

Furring members to hold the insulation in place are unnecessary. If vapor-retarder-faced insulations are required, use only special low flame-spread vapor retarders recommended for exposed applications. The vapor retarder should, in most cases, face toward the crawl space, the warm-in-winter side. Consult individual manufacturers' instructions. Two methods of installing insulation are recommended.

First, after insulating the band joist separately, nail the insulation to the sill plate with  $\frac{1}{2}$  x  $1\frac{1}{2}$  nailer strips. (See Figure 17.) The insulation should be snug against the piece next to it. The insulation should hang down to the bottom of the wall and extend out onto the ground cover (usually polyethylene) about 2 feet. Where the insulation bends onto the ground cover, the insulation may be held in place by laying small rocks or bricks on the insulation.

Figure 17

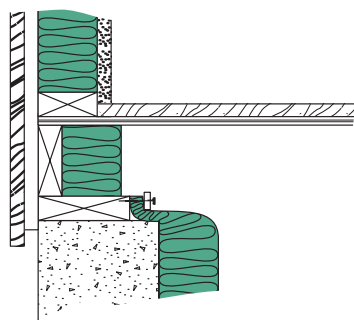

An alternate method of insulating masonry walls is to run the insulation up the wall, past the sill plate to the subfloor. Again, insulate the band joist separately. (See Figure 18.)

Figure 18

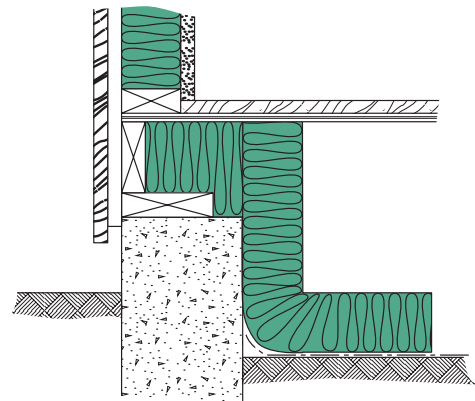

### All-Weather Wood Foundation

Insulate the band joist separately. Where the crawl space floor is concrete, install the insulation as recommended for wood-frame walls. If the crawl space floor is soil, apply the insulation and the ground cover. (More information on ground cover is detailed on page 12.)

## Insulating Around Obstructions

### General

It is difficult to describe every situation that will be encountered by the insulation installer. In general, however, the installer should be guided by the need to reduce heat flow around or through obstructions and to protect mechanical systems.

### Electrical

Junction boxes for wall switches and convenience outlets at outside walls should be insulated between the rear of the box and the sheathing. Place insulation behind the junction box and if necessary, cut insulation to fit snugly around it. (See Figure 19.)

Where electrical wiring passes through a stud cavity and is located close to the inside wall surface, insulation should be pressed behind the

wiring. When the wiring is in the center of the cavity, either a shallow cut in the insulation may be used to allow the wiring to pass through the insulation or it may be split lengthwise and the wiring sandwiched within. (See Figures 20 and 21.)

Figure 19

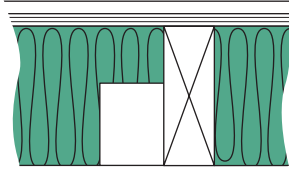

Figure 20

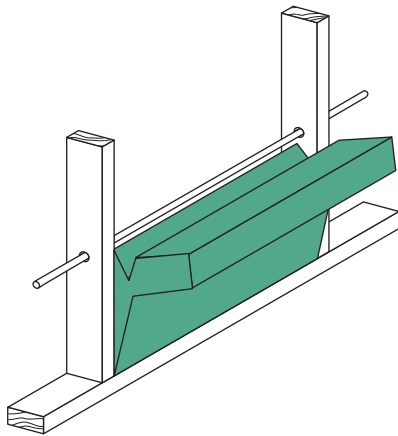
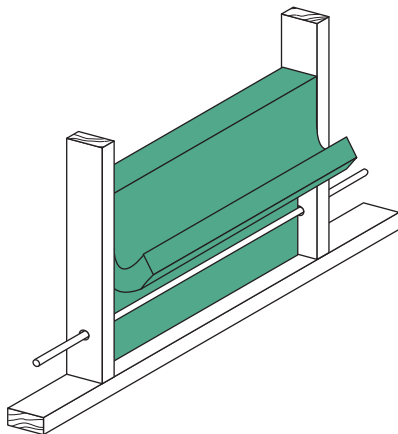

Figure 21



The National Electrical Code contains the following recessed lighting fixture requirement: “Thermal insulation shall not be installed within 3 inches of the recessed fixture enclosure, wiring compartment or ballast and shall not be so installed above

the fixture as to entrap heat and prevent the free circulation of air unless the fixture is otherwise approved for the purpose.” The recommendations of the NEC should always be followed.

## Plumbing

Insulation should be placed between the piping in exterior walls and the exterior wall sheathing. Sidewalls where plumbing fixtures are to be placed must be insulated before the fixtures are installed. To guard against pipes freezing, insulation should never be placed between piping and the warm side of the wall. (See Figure 22.)

Figure 22

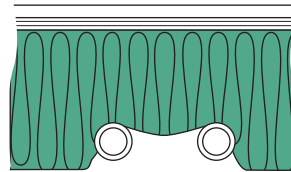

## Air Ducts

Any air duct in an unconditioned space must be insulated. Insulated air ducts contribute to the home’s overall indoor environment by delivering heated and cooled air at design temperatures and absorbing noise generated by central air conditioning equipment, air rush and cross-talk. In addition, insulated air ducts control the heat loss or gain through the air duct walls.

If an air duct runs through an unconditioned space such as an attic or a side wall, it should either be insulated with duct wrap or batt insulation should be applied between the duct and the wall sheathing.

## Openings Through Building Sections

Where pipes, wiring, or ductwork penetrate a building section, insulation should be packed tightly into the openings to reduce air infiltration.

# Vapor Retarders

## What is a Vapor Retarder?

A vapor retarder is defined by ASTM C 755 as a material that adequately retards the transmission of water vapor under specified conditions. The permeance of an adequate retarder for residential construction will not exceed 1 perm. (The perm is a measure of the flow of water vapor through a material.)

## What Does a Vapor Retarder Do?

Occupants of buildings, certain appliances, and plumbing equipment generate moisture that is carried in the air as vapor. As moisture vapor moves from a warm interior through construction materials to a cooler surface, the moisture may condense as water, which could damage the building. It is for this reason that vapor retarders, which retard the flow of moisture through construction materials, are installed in buildings. By locating vapor retarders on the side of the insulation toward the warm living area, moisture vapor is kept away from cold surfaces on which it might condense to liquid water.

## Vapor-Retarder-Faced Insulation

The vapor-retarder facing should usually be installed toward the warm-in-winter side of the construction. This means that in ceilings the vapor retarder faces down, in walls it faces the inside, and in floors over unheated spaces it faces up. In hot, humid (Gulf Coast) climates, vapor retarders can be installed facing the outside. Check local practices and/or building codes.

## When Is a Vapor Retarder Required?

Good construction practice calls for installing a vapor retarder in walls of all new buildings. Local building practice should be followed with regard to the need for vapor retarders in ceilings.

## Cautions

Always follow these rules when working with vapor-retarder-faced insulation:

- Standard vapor retarders are combustible and should not be left exposed. For this reason they must always be covered. (Only special low flame-spread vapor-retarder facings can be left exposed.) Consult individual manufacturers' installation instructions. Included are such spaces as garages, storage rooms, utility rooms, and laundries. Covering standard vapor retarders is a requirement of the model codes issued by Building Officials and Code Administrators International, the International Conference of Building Officials, and the Southern Building Code Congress International. To comply with the codes, interior finish materials must have flame spread ratings of 200 or less. NAIMA recommends that standard vapor retarders also be covered in areas not ordinarily occupied but accessible for service work. Gypsum board is commonly used. NAIMA recommends that all combustible vapor retarders should bear printed statements that the vapor retarder is flammable (will burn), should not be left exposed and that special care must be taken to keep open flame and other sources of heat away from the facing.
- Batts and rolls may be installed one on top of the other in ceilings where there is adequate space. In most cases, only the bottom layer should have a vapor retarder, which should face down toward the space that is warm in winter. Additional layers normally should be unfaced. If unfaced insulation is not available, use the faced type but remove the facing completely before installation.
- Repair damaged vapor retarders. Rips or tears in the vapor retarder facing may be repaired by covering the damaged area with scrap vapor retarder material and taping it in place or, in the case of small rips, by using duct tape or polyvinyl tape.
- Care should be taken not to staple into electrical wiring when installing faced insulation or separate vapor retarders.

## Other Vapor Retarder Materials

Separate vapor retarders are used in some constructions. When required, a separate vapor retarder should be installed at the warm-in-winter side of the framing. (In hot, humid climates, vapor retarders are sometimes omitted or installed outside the insulation.) Four-mil or thicker polyethylene sheeting, available in rolls, is placed horizontally and stapled to the face of the framing. If more than one sheet of polyethylene is required, overlap the sheets across two framing members. Foil-backed gypsum board is also an effective vapor retarder.

## Ground Covers

Where the floor of a crawl space is soil or gravel, a ground cover should be used to limit the evaporation of water moving from damp soil into a crawl space. It is recommended that a ground cover be 4-mil or thicker polyethylene film or 55-pound-or-heavier asphalt roll roofing, laid on the floor and up the walls approximately 6 inches. The joints of the ground cover should lap at least 12 inches. Overlaps and edges should be held in place by scrap brick, rocks or other suitable material.

## Clothing and Equipment

### Clothing

When installing fiber glass insulation:

- Wear a long sleeved shirt loose at the neck and wrists, long pants, gloves and cap.
- Wear eye protection (safety goggles, safety glasses or a face shield or a combination of these, as appropriate).
- Wear a NIOSH-certified disposable dust respirator (N95 or greater.) An appropriate training and fit testing program must be incorporated into a respiratory protection program. For more detailed information on recommended work practices, contact NAIMA or the individual manufacturer.

## Equipment

For cutting insulation the best knife has been found to be one with a serrated blade. Blades should be replaced periodically as they tend to dull during use. Other equipment may be preferred by the installer.

## What NAIMA Tells Consumers

In publications distributed to homeowners, NAIMA advises them on selecting contractors and dealing with their application crews. Here's an excerpt from the booklet "How to Save Money by Insulating Your Home."

If you prefer to hire an insulation contractor, you can find one by:

- Asking your utility company for suggestions.
- Consulting friends and neighbors.
- Looking in the phone book "Yellow Pages" under "Insulation Contractors-Cold & Heat" or a similar heading. Remember that a contractor has the special skills needed to insulate sidewalls as well as to do an expert job of insulating ceilings and floors.

The next step is to call in two or three contractors to quote your job. You should judge contractors' reliability as well as their prices. Here are some suggestions:

- Check a contractor with the local Better Business Bureau (also listed in the phone book). Or ask your bank to get a report on credit ratings.
- Ask contractors for references, including other homeowners for whom they have done work. Check them out.
- Give all the contractors exactly the same description of what you want done. For example, say, "I want to add R-19 to my attic floor," then stay with that specification and that way of saying it. Don't be satisfied if a contractor says, "Okay, I'll add 6 inches."

Not all brands of insulation have the same R-value per inch. Six inches of one brand might not have

the same R-value as 6 inches of another. Stick with R-values. If contractors won't deal with you in R-value language, don't deal with them.

- If a contractor is going to blow insulation in your attic, how can you tell if you're getting the R-value you've requested? First of all, make sure the written contract states R-value, the minimum thickness and the number of bags of insulation to be used to achieve the R-value. In addition, you can check the bag label yourself.
- Ask contractors how they pay installers, by the number of square feet they install or by the hour. If they pay them by square footage, they might do a hasty job on your house just so they can get on to the next one.
- Ask contractors about the insurance they carry. Do they have insurance to protect their own workers if they are injured? Are you covered if a worker damages your house?

## Material Specifications

Assurance of insulation material quality is extremely important to the safety and effectiveness of installed insulation. NAIMA recommends the use of fiber glass insulation that meets the requirements of the current edition of ASTM C 665 Standard Specification for Mineral Fiber Blanket Thermal Insulation.

## Thermal Recommendations

When building a new home, consumers and builders alike should make sure their homes are insulated to save energy and to provide more comfortable living. The International Code Council (ICC) publishes the International Energy Conservation Code (IECC) which recommends specific thermal performance requirements.

Figure 23 shows the Department of Energy's (DOE) recommended R-values for one and two family homes. The R-values recommended by DOE exceed those required by most building codes.

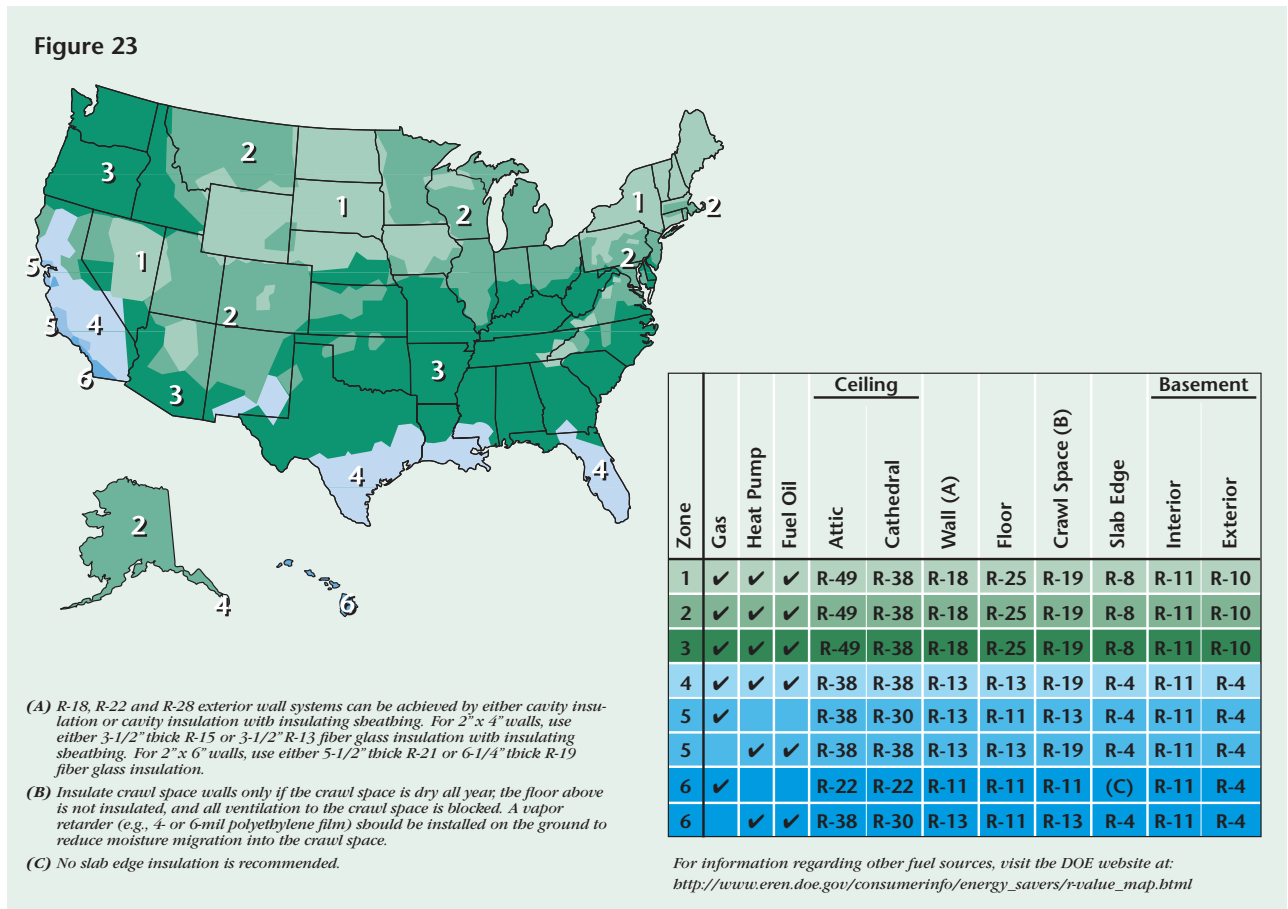

NAIMA is the association for North American manufacturers of fiber glass, rock wool, and slag wool insulation products. Its role is to promote energy efficiency and environmental preservation through the use of fiber glass, rock wool, and slag wool insulation, and to encourage the safe production and use of these materials.

In May 1999, NAIMA began implementing a comprehensive voluntary work practice partnership with the U.S. Occupational Safety and Health Administration (OSHA). The program, known as the Health and Safety Partnership Program, or HSPP, promotes the safe handling and use of insulation materials and incorporates education and training for the manufacture, fabrication, installation and removal of fiber glass, rock wool and slag wool insulation products. For more information about the HSPP, contact NAIMA.

### **NAIMA Building Insulation Committee:**

**CertainTeed Corp.**, 800-233-8990  
750 E. Swedesford Road, Valley Forge, PA 19482

**Guardian Building Products, Inc.**, 800-569-4262  
P.O. Box 207, Greenville, SC 29602

**Johns Manville** 800-654-3103  
P.O. Box 5108, Denver, CO 80217

**Knauf Insulation**, 800-825-4434  
One Knauf Drive, Shelbyville, IN 46176

**Owens Corning**, 800-GET-PINK  
One Owens Corning Parkway, Toledo, OH 43659

### **For additional information contact:**

**NAIMA**  
**44 Canal Center Plaza**  
**Suite 310**  
**Alexandria, Virginia 22314**  
**Tel: 703-684-0084**  
**Fax: 703-684-0427**  
**[www.naima.org](http://www.naima.org)**